

motion

02.2021

THE MAGAZINE WITH DRIVE

Driving sustainable growth

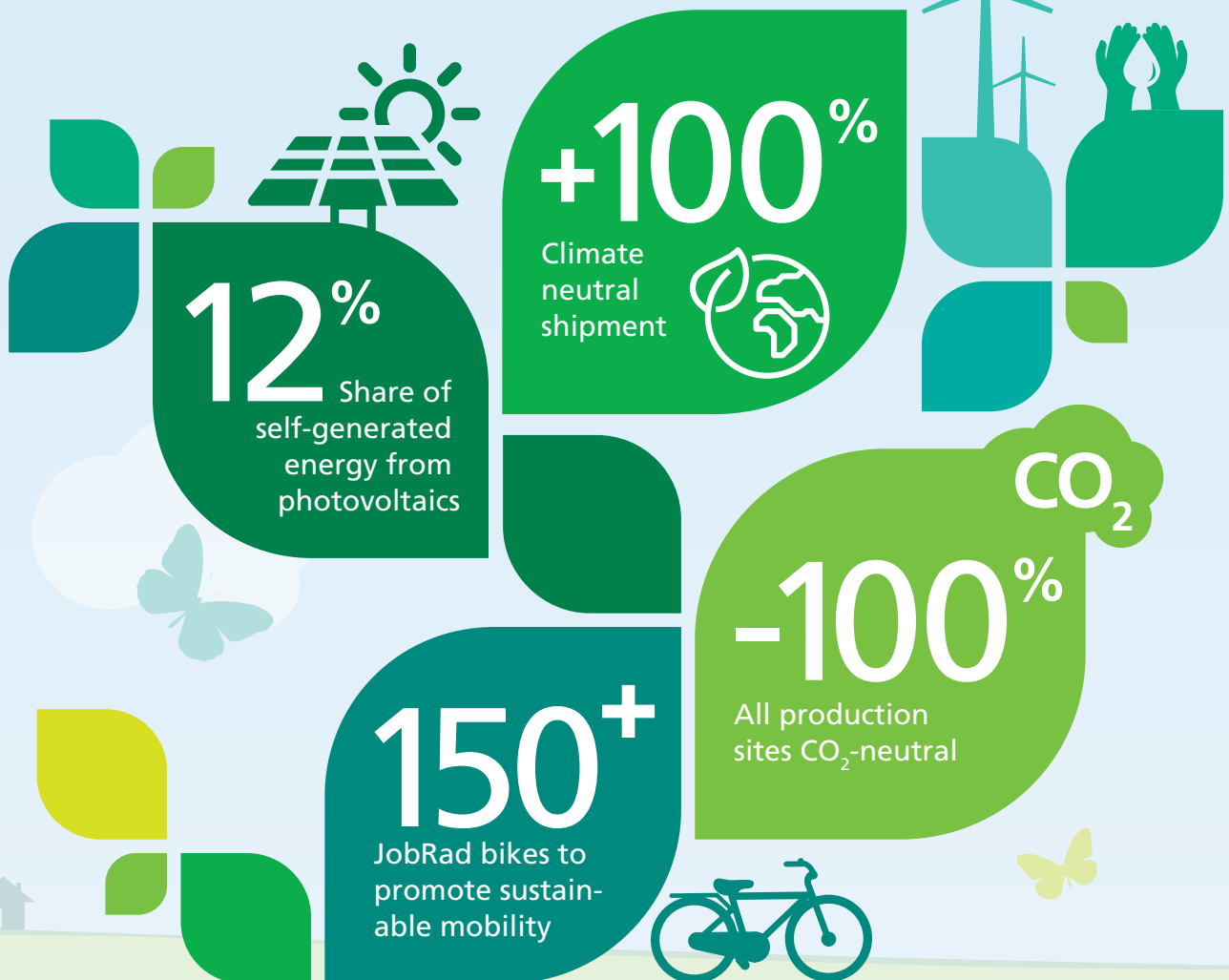

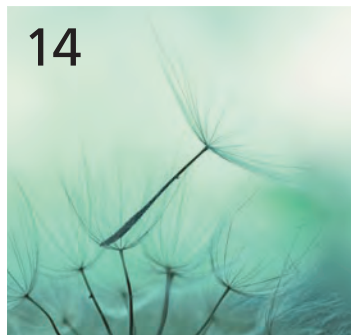
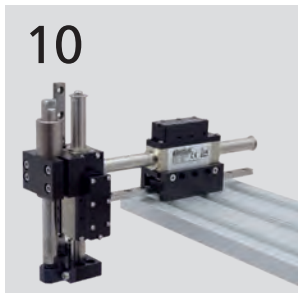

NEWS

04 New Management Structure at FAULHABER

New management to lead the group of companies from January 2022

NEWS

05 Exceptionally high speed and dynamics

Presentation of the new stepper motor AM3248

FACTORY AUTOMATION & ROBOTICS

06 Firmly on track to autonomous production

The startup Evocortex and FAULHABER together ensure smooth full automation

MEDICAL & LABORATORY EQUIPMENT

10 Intelligent modular system for quick solutions

Miniaturized linear motors from FAULHABER unlock new potential for the pharmaceutical industry

PRECISION MONITORING & MEASURING TECHNOLOGY

14 Because every grain of pollen counts...

A pollen monitor driven by FAULHABER provides allergy sufferers with reliable forecasts

MEDICAL & LABORATORY EQUIPMENT

18 Automation takes a lot of finesse

Zimmer Group together with FAULHABER drive technology provides the required precision in laboratory automation

WATCHMAKING INDUSTRY

22 Time follows function

How FAULHABER's smallest series motor is revolutionizing product design for the watch maker Ressence

SUSTAINABILITY

26 Driving sustainable growth

Step by step towards becoming a CO₂-neutral company group by reorganizing production and logistics



Dear readers,

In order to preserve our natural ecosystems for future generations, FAULHABER has set itself the goal of achieving sustainability in all of its facets and is acting accordingly. We are aware of our responsibility to future generations and have therefore enshrined environmental protection and the careful use of resources in our corporate mission statement. For FAULHABER, the focus on sustainability has long been one of its strategic considerations, like innovation and growth. In 2020, FAULHABER became one of the first production companies in Germany to achieve CO₂ neutrality – this now applies to all production sites.

Apart from logistics, the pick-and-place process – i.e. retrieving objects and depositing them at a different location – is another highly important task in industrial production. In modern systems, this is performed by automated grippers. They must be able to operate both powerfully and delicately and do so precisely and reliably millions of times over. Increasingly, the necessary power comes from electric motors, such as the BX4 product family from FAULHABER. More on this and other exciting drive technology topics can be found in the latest edition of the magazine.

This issue will mark the last time we get to talk to you, and we would like to take the opportunity to say our goodbyes. After 17 years (Dr. Thomas Bertolini) and 22 years (Gert Frech-Walter) respectively, we will be handing over management of FAULHABER to our successors at the end of the year. More about this in the magazine. We would like to thank you all for your loyalty, trust, and the excellent, constructive, cooperative and successful collaboration over the years. We wish you all the best for your future, both professionally and personally.

You can expect the future cooperation with the new management to continue successfully at the same level of quality you are accustomed to.

We hope you enjoy reading this issue!

Sincerely

Gert Frech-Walter
Managing Director

Dr. Thomas Bertolini
Managing Director

Issue 02.2021

Publisher / Editor:

DR. FRITZ FAULHABER
GMBH & CO. KG
Schönaich · Germany
Phone: +49 (0)70 31/638-0
Fax: +49 (0)70 31/638-100
E-Mail: info@faulhaber.de
www.faulhaber.com

Layout:

Werbeagentur Regelmann
Pforzheim · Germany
www.regelmann.de

Picture credits & copyright:

All rights reserved. The rights for the graphics and pictures used as well as brand names mentioned are held by the respective owner. The copyright for the articles is held by the editor. Reproduction or electronic processing of content, even sections thereof, is only permitted with the explicit written consent of the editor.

Publication frequency & subscription:

FAULHABER motion is published twice a year and is delivered to customers, interested parties and employees of FAULHABER free of charge.

FAULHABER motion is also available in digital format:
www.faulhaber.com/motion

NEW MANAGEMENT STRUCTURE AT FAULHABER NEW MANAGEMENT TO LEAD THE GROUP OF COMPANIES FROM JANUARY 2022



Schönaich. In January 2022, the year of Dr. Fritz Faulhaber GmbH & Co. KG's 75th anniversary, the drive specialist will get a new management structure. Due to retirement, the previous managing directors, Dr. Thomas Bertolini and Gert Frech-Walter, will be handing over the reigns to the new five-person management team around Karl Faulhaber.



www.faulhaber.com/en/news-events/news

"Their vision of standardized and synchronized production across locations was just as important to FAULHABER's success at the beginning of the new millennium as the integration of the international subsidiaries into the FAULHABER Group during their joint tenure. In their capacity as managing directors, they also accepted numerous awards on behalf of FAULHABER, such as the "Factory of the Year 2018" in the category "Outstanding small-batch production". Dr. Thomas Bertolini and Gert Frech-Walter are handing over an extremely well-positioned company that is ready for the challenges of tomorrow. We would like to thank the two of them for their commitment and dedication, and we hope they will enjoy their well-deserved retirement," says Karl Faulhaber.

Expanded new management

As part of the changeover the management team was expanded. In addition to Karl Faulhaber (Sales, Marketing), Hubert Renner (Order Management), Markus Dietz (Finance, Controlling), Lutz Braun (HR, Legal) and Dr. Udo Haberland (R&D, Innovation) will also be entrusted with the management of the family business.

Continuity is important for the success of the family-run group of companies. As a member of the new management team, of which some members have decades of experience in various leadership positions at FAULHABER, Karl Faulhaber will be representing the third generation of the founding family to take the helm of the company. Together with its customers, partners, and employees, FAULHABER will continue to focus on healthy growth and profitability.

"After 17 years (Dr. T. Bertolini) and 22 years (G. Frech-Walter) respectively, we will hand over the reigns to the new management at the turn of the year. We would like to thank our partners and customers for their loyalty and outstanding cooperation. This is also an incentive for the new management, whom we wish the best of success," said the outgoing managing directors Dr. Thomas Bertolini and Gert Frech-Walter.

EXCEPTIONALLY HIGH SPEED AND DYNAMICS

With its new AM3248 stepper motor, FAULHABER is opening up new performance dimensions for a whole series of sophisticated applications. With a maximum of 10,000 rpm, this stepper motor achieves a speed five times higher than comparable stepper motors and, combined with a gearhead reduction of 100:1, it delivers a torque of 5 Nm. The new drive also scores points with respect to the efficient use of installation space. The motor achieves this level of performance despite its small diameter of just 32 mm.

Particularly in applications where rapid acceleration and changes in direction are important, the motor utilizes its low inertia and high speed from the very first step. It performs 48 steps per revolution and with 51 mNm provides a high static torque. Newly developed, larger ball bearings further increase the service life of this already robust drive type. For its size class, the performance values that it achieves in combination with a 32 GPT gearhead are unrivaled on the market. Thanks to these features, the AM 3248 stepper motor is ideally suited to a wide range of applications in areas such as aerospace, laboratory automation, large optical systems, the semiconductor industry, robotics and 3D printing. If required, the motor can be combined with an IE3 magnetic encoder.

The advantages at a glance:

- Cable length of up to 5 m
- Efficient operation with low torque ripple
- No reference run after switch on necessary



www.faulhaber.com/en/news-events/news



FIRMLY ON TRACK TO AUTONOMOUS PRODUCTION

In the age of the Internet of Things (IoT) and Industry 4.0, intralogistics play a critical role. For fully automated production from batch size one, the right parts must be transported to the production stations at the right time. With an innovative, autonomous transport system, startup company Evocortex in collaboration with FAULHABER is able to offer the high level of flexibility and precision required by such a large number of variants.

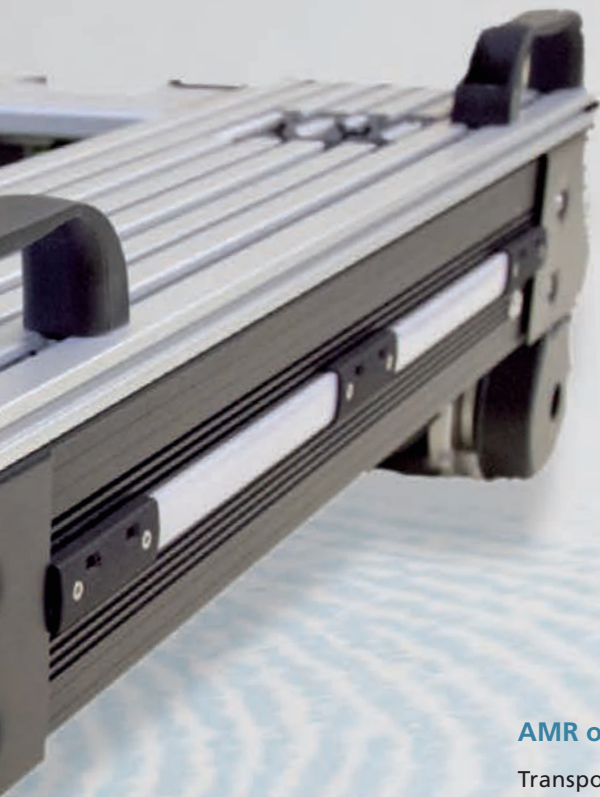

"Conventional AMR often require spatial adaptations to the travel paths or even technical changes to the processes. For example, the vehicles need visual markings for orientation, and paths and intersections must meet specified dimensions and curve radii. We wanted to create transport robots that adapt to the needs of the customer and not the other way around."

Managing Director Hubert Bauer

AMR on the advance

Transport solutions for materials are becoming increasingly customized and need to be as fully automated as possible. Mobile robot platforms – known in the industry as autonomous mobile robots (AMR) – are, therefore, on the advance in warehouse and production halls around the world. Focusing on this market is the Nuremberg-based startup Evocortex, which was founded in 2016 with the participation of experienced robot experts. The company is pursuing a completely new AMR concept in close collaboration with the neighboring Technical University of Nuremberg and other educational and research institutions.

The "fingerprint" of the hall floor indicates the exact position

The autonomous mobile robots (AMR) from Evocortex require absolutely no preinstalled guidance system to determine their location and find the right way. They orient themselves simply using the irregularities in the hall floor. These exist even on seemingly smooth concrete floors and are registered by a high-resolution camera that is mounted on the underside of the vehicle. The robot uses the images to obtain a "fingerprint" of the hall

floor. Behind this ingenious system is the self-developed Localization Module (ELM) from Evocortex.

During the initial teach process, the robot moves across the hall floor in a grid pattern. With the help of complex algorithms, a highly precise map is produced from a pattern of individual points. In the future, this will also be performed using self-learning artificial intelligence. In addition, the controller detects the vehicle's own movement. By combining the data, it can – on a theoretical area of one square kilometer – position precisely to within a millimeter. To do this, just three identified points are needed. Even if 50% of the floor is covered with sawdust, the ELM remains unfazed and ensures robust, precise and exact navigation. Permanent new scratches in the floor are added to the map; features that disappear are removed after a certain time.

The AMRs can optionally be equipped with additional LIDAR sensors on one or two fronts. These scan the room in the direction of travel and detect obstacles – including those that are moving, such as people who cross the travel path. The vehicle stops immediately to ensure the safety of employees.

High-resolution camera on the underside

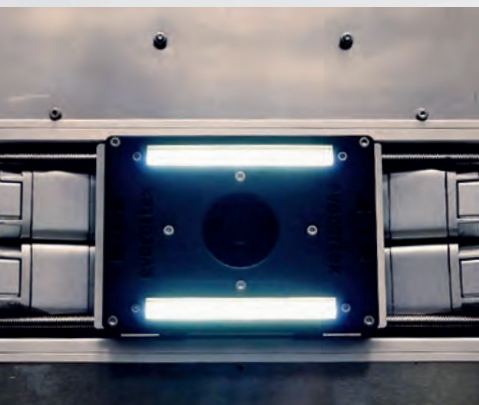



the 45 degree angles are arranged with a 90 degree offset. Thus, each wheel tries to move in a different direction. By varying the direction of rotation and speed of the individual wheels, the vehicle can be steered in any direction from a standstill or rotated on the spot. On the horizontal plane, it can thus move as freely as a hover car. The Mecanum wheels thereby enable agile and omnidirectional movement of the robot.

Unrestricted mobility with Mecanum wheels

A normal wheel moves in only the same direction as its axis. To precisely position a vehicle with such wheels, one must maneuver in the same way as when parking a car. To avoid this, the developers at Evocortex opted for the Mecanum wheel. Instead of a closed running surface, barrel-shaped rollers are mounted on its rim. They are fastened at an angle of 45 degrees to the axle of the wheel and can turn about their own angled bearing axis. The shape, size and spacing of the rollers are selected to give the wheel a continuous rolling surface.

When the Mecanum wheel turns, two force components arise: in the direction of rotation of the entire wheel as well as at a right angle to the wheel's direction of rotation. Thus, the resulting direction of movement lies in between: the Mecanum wheel "wants" to move at an angle of 45 degrees to the axial direction.

Due to the mobility of the rollers, however, it has no directional stability. If there are additional forces, its own direction of movement can be deflected in any direction. On a vehicle with four Mecanum wheels, each of

Scalability in millimeter increments

The AMRs from Evocortex offer yet another dimension of flexibility: they enable a practically unlimited selection of sizes. "If desired, we can adapt our robot to our customers' requirements in millimeter increments," emphasizes Hubert Bauer. "Every external dimension between 400 by 480 and 800 by 1200 millimeters can be realized." With the EvoRobot R&D and EvoRobot Industrial product lines, these also correspond approximately to the external dimensions of the load-bearing platform. All technology – sensor, controller, lifting unit and wheel drives – are housed beneath the platform. The wheel drive module is a decisive element for this scalability. It is located directly above the wheel and, together with the wheel, forms a standardized, independent function unit. As a result, the wheels can be mounted at any distance from one another. The decisive prerequisite for this arrangement is a powerful motor with very small dimensions.



"We took a very close look to determine which motors on the market were candidates for this application," says Hubert Bauer, recalling the development phase. "Only with FAULHABER were we able to find the power density that we needed. The motors from the competition had no space left for the required torque."

Enormous power, minimal size

The wheel modules of the EvoRobot are equipped with DC-Micromotors of the 3257... CR or 3272...CR series. Each is fitted with an IEF3 encoder and a 38/25 gearhead. For fast stopping and to ensure the wheels remain locked in position once stopped, the wheel motors are also equipped with a brake. "Thanks to the enormous power of these micromotors, the EvoRobot can provisionally transport pallets with a load of up to 120 kilograms," explains Hubert Bauer. "This also functions on a ramp with a slope of up to five degrees and a speed of one meter per second." The EvoCarrier product line is designed for transporting small load carriers. In the inner workings of this AMR, things are even tighter. The ground clearance too is less than 100 mm here.

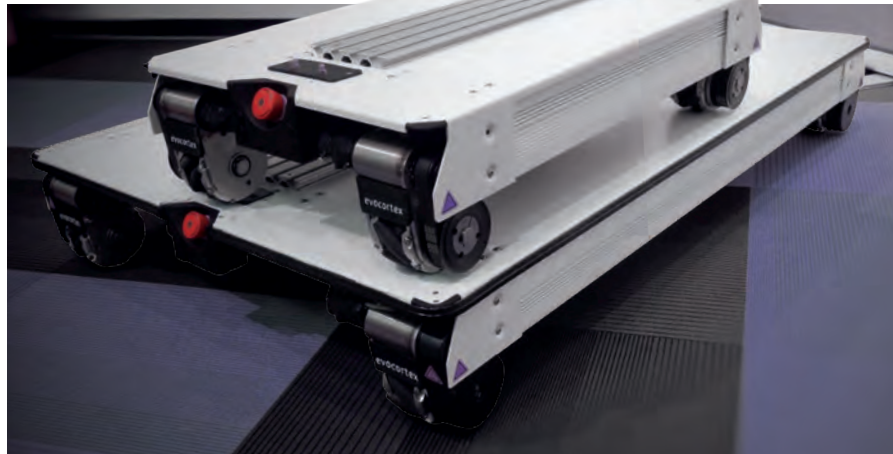

The developers therefore selected a so-called "flat rotor motor" here – a brushless motor of the 4221... BXT series measuring just 21 millimeters in length. In the long term, the managing director believes there will be a transition to brushless motors with the EvoRobot as well and the modules will be further standardized. In the next step, Evocortex plans to couple the control of 2 or 4 EvoCarriers. They will then be able to together transport a euro pallet or even an entire shelving unit – yet another degree of freedom for the application.

In addition to the ratio between power and volume, it is above all the zero maintenance and the reliability in continuous operation that play an important role in the operation of the AMRs. "Our requirements in terms of service life are more than satisfied by the FAULHABER motors," says Hubert Bauer. "In addition, it is of advantage that the drives function with all common industrial controls. The experts from FAULHABER were also very helpful in finding the optimum parameter settings for series production."

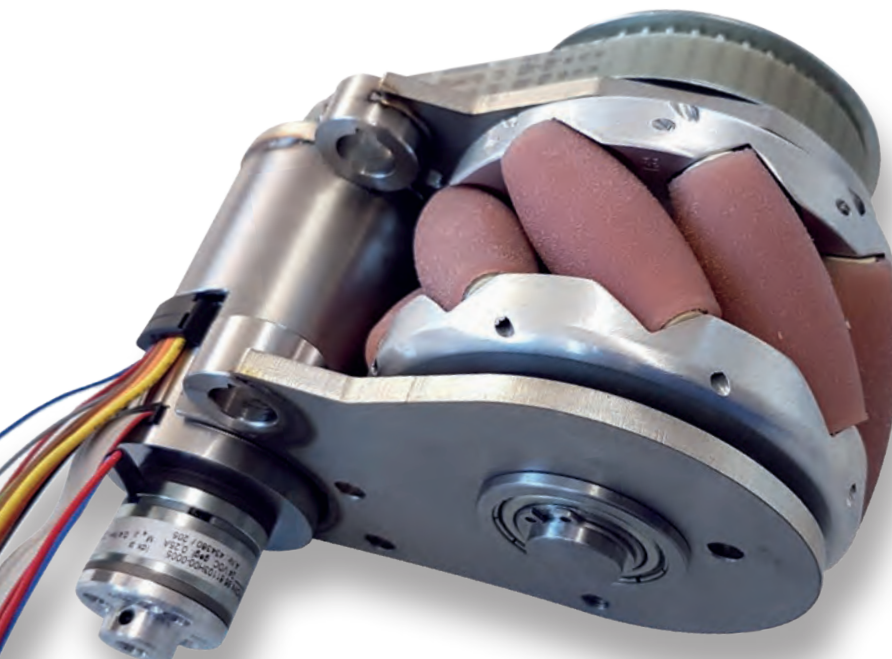

FAULHABER CR
DC-MICROMOTORS
WITH GRAPHITE COMMUTATION



www.faulhaber.com/en/markets/factory-automation-robotics/
www.evocortex.org

INTELLIGENT MODULAR SYSTEM FOR QUICK SOLUTIONS

Since the beginning of the coronavirus crisis, the pharmaceutical industry and laboratories have been under pressure to realize the highest possible levels of automation. This requires a number of new analysis and testing devices, production lines as well as filling and packaging systems, the efficiency of which is dependent on the level of automation. Miniaturized linear motor axes and modules for single-axis or multi-axis applications open new possibilities here. Designed as a modular system, they are suitable for a wide range of tasks in laboratory automation and the pharmaceutical industry.

They are powered by FAULHABER linear motors.



Miniature linear motor module QM02-2070
Stroke up to 160 mm · Peak force 28 N

The engineers from Jung Antriebstechnik u. Automation GmbH JA² responded to calls from the pharmaceutical industry, the analysis sector and the medical technology industry for small but functional automation solutions with the development of a new modular mechatronic system called QuickLab. With the small QM02 linear motor modules for up to 160 mm stroke and the QA02 linear motor axes for strokes up to 220 mm, short-stroke applications can be realized with high dynamics and accuracy, e.g., in laboratory and analysis technology or in testing systems. Through the mechanical construction and precision guides in combination with two ball carriages, the modules and axes are very rigid and offer high repeatability during positioning of

$\pm 50 \mu\text{m}$ in spite of their lightweight construction and low moving mass. Depending on the load, travel speeds up to 3 m/s and acceleration up to 50 m/s² are possible. The axes and modules can be individually combined with one another. In this way, pick-and-place applications can be realized as can automatic solutions for separating, grouping, testing or plating samples or other sensitive products. With a width of 22 mm, QuickLab perfectly covers the need for miniaturized single- and multi-axis handling systems. Moreover, the appropriate accessories such as weight force compensation, magnetic holding brakes, external position sensors and adapter plates are offered.



Miniature linear motor module QM02-2070
with built-in weight force compensation for lifting drives

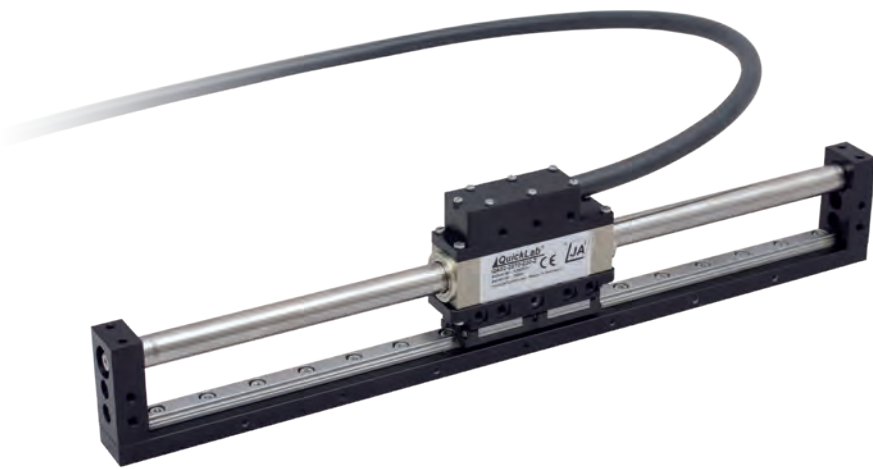

Miniature linear motor axis QA02-2070
with trailing-chain cable up to 30 m in length
Stroke up to 220 mm · Peak force 28 N

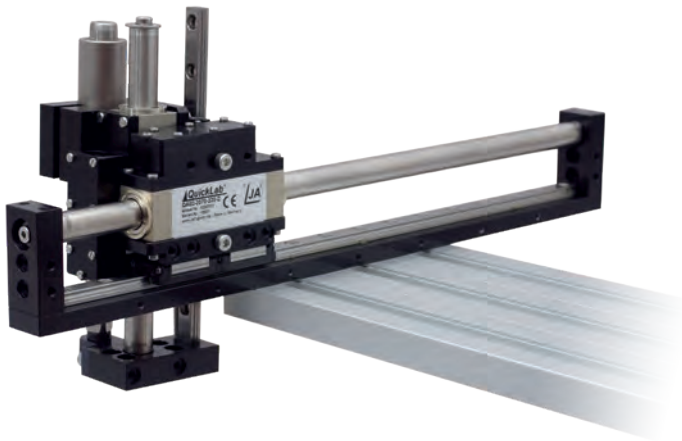

Only two screws are needed!
XZ planar gantry combined from linear motor axis QA02 and
linear motor module QM02 with weight force compensation

High dynamics and precision

"The linear motors are the 'heart' of our modular automation system and the requirements placed on them are very high," explains Wilhelm Jung, Managing Director at JA². "The motors must operate highly dynamically, be precisely controllable and have suitable dimensions. The linear motors from FAULHABER convinced here with their innovative functional principle, which differs from "classic" solutions:

Linear motors can be constructed in a number of different ways because all principles of "rotating" electric motors can generally be implemented in linear motors by mapping the round air gap onto a straight line. To do this, the originally circularly arranged electric excitation windings are basically unwound on a flat path. The magnetic field then pulls the rotor over the travel path. There are, however, still other possibilities: The LM2070 DC linear drives are not constructed as such "surface rotors" with carriage and guide. Instead, theforcer rod is guided within a 3-phase self-supporting coil. "This design produces an exceptionally good relationship between linear force and current and high dynamics. In addition, there are no cogging torques, thereby making the linear motors ideal for use in our modular QuickLab system."

Maximum performance in the smallest dimensions

The LM2070 linear motors are available with stroke lengths from 40 to 220 mm. Despite the compact stator dimensions of 20 x 20 x 70 mm (W x H x L), the small linear DC servomotor has impressive mechanical performance indicators.

The continuous force is 9.2 N, and up to 28 N of peak force is available. The robust plain bearing of the forcer rod easily handles the high speeds of up to 3 m/s. At the same time, the miniature powerhouse can be very precisely controlled. The integrated Hall sensors already ensure an absolute positioning accuracy of ± 0.1 mm and a repeatability of ± 50 μ m. With an optional external sensor, these figures can be improved to ± 0.01 mm and a repeatability of ± 1 μ m. On top of this comes practically maintenance-free operation as the motor has no moving wear parts. Moreover, the linear drive operates nearly noise-free. "This is important above all if personnel and handling systems work in the same room, as is often the case in laboratories," adds Wilhelm Jung.

Trailing-chain cable connection

An important point for handling systems is the connection technology. The linear motors are normally delivered with a max. 30 cm long cable connection. In automation systems, however, the switch cabinet is usually some distance from the actual drive. "Between the motor and the controller in the separate switch cabinet, there can then be 10, 20 or more meters," says Wilhelm Jung. With the QuickLab modular system, there is therefore a special, multi-shielded cable that transfers the motor power and the position sensor signal between motor and controller interference-free over up to 30 m. It is fastened with a cover directly to the motor with strain relief, can be plugged in and is also designed for use

with cable chains, i.e., for mobile use. The single-cable technology simplifies installation thanks to the prefabrication of both ends.

The mechatronic kit tailor made for laboratory automation has already proven itself in practical use. Wilhelm Jung confirms this: "Many manufacturers and suppliers of analysis accessories today rely on our systems. Demand is currently enormous – including from other areas such as optics and testing technology." Always present as the driving force: the small, powerful LM2070 linear drives.



FAULHABER LM2070
LINEAR DC SERVOMOTOR



www.faulhaber.com/en/markets/medical-laboratory-equipment/
www.ja2-gmbh.de

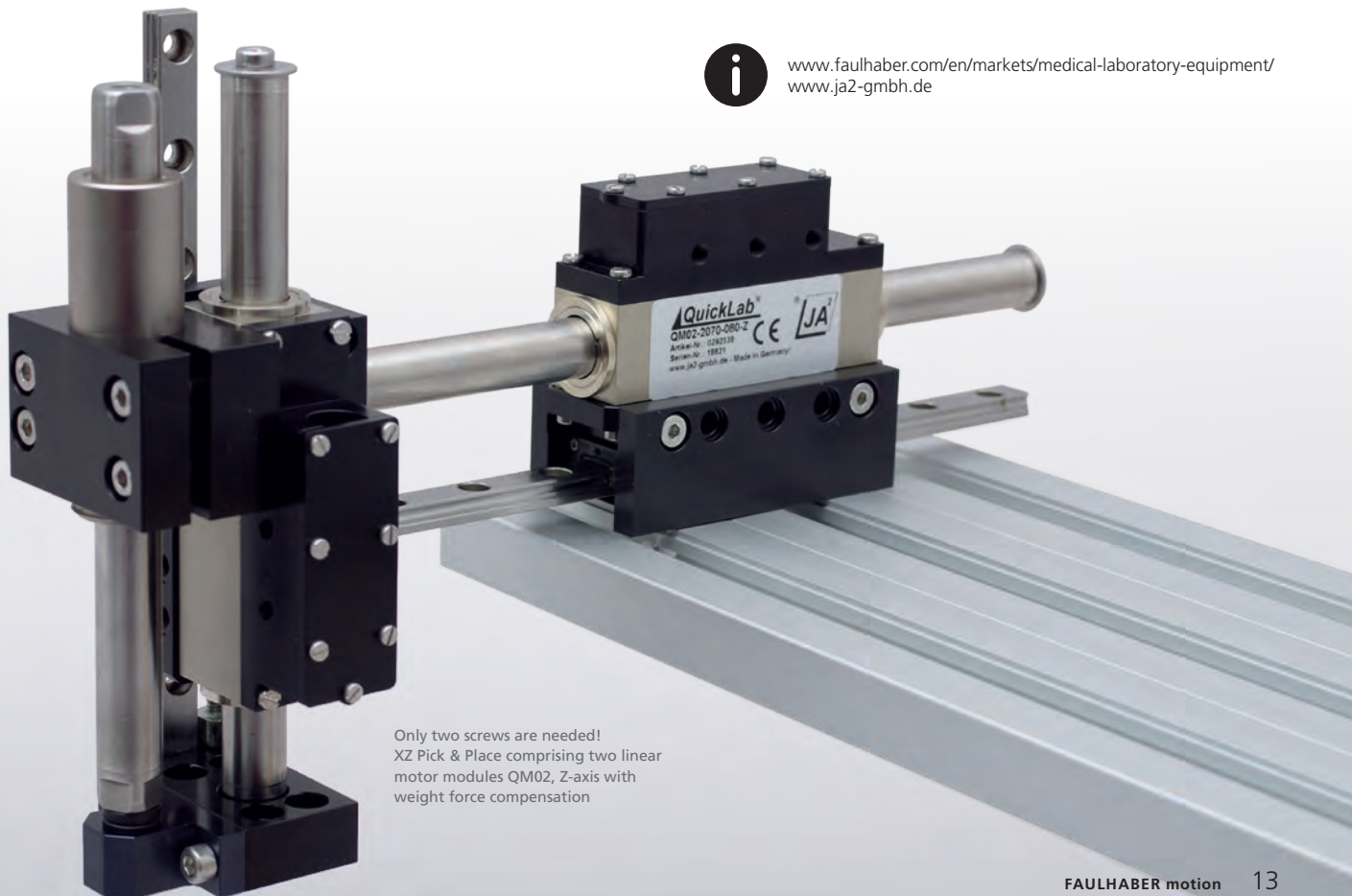

Only two screws are needed!
XZ Pick & Place comprising two linear motor modules QM02, Z-axis with weight force compensation

BECAUSE EVERY GRAIN OF POLLEN COUNTS



Ambrosia, birch, alder, hazel: About 30% of the population are to a lesser or greater degree affected by the pollen of these and other plants, trees, and bushes. The symptoms can range from relatively mild rhinitis (hay fever) through to anaphylactic shock, which may be life-threatening. Knowing the pollen count on any given day at a specific location is thus very important for the people affected. The FAULHABER drives used in the fully automatic pollen monitors from Helmut Hund GmbH and installed at various locations ensure that the pollen meters provide reliable and, above all, timely data for pollen forecasting.

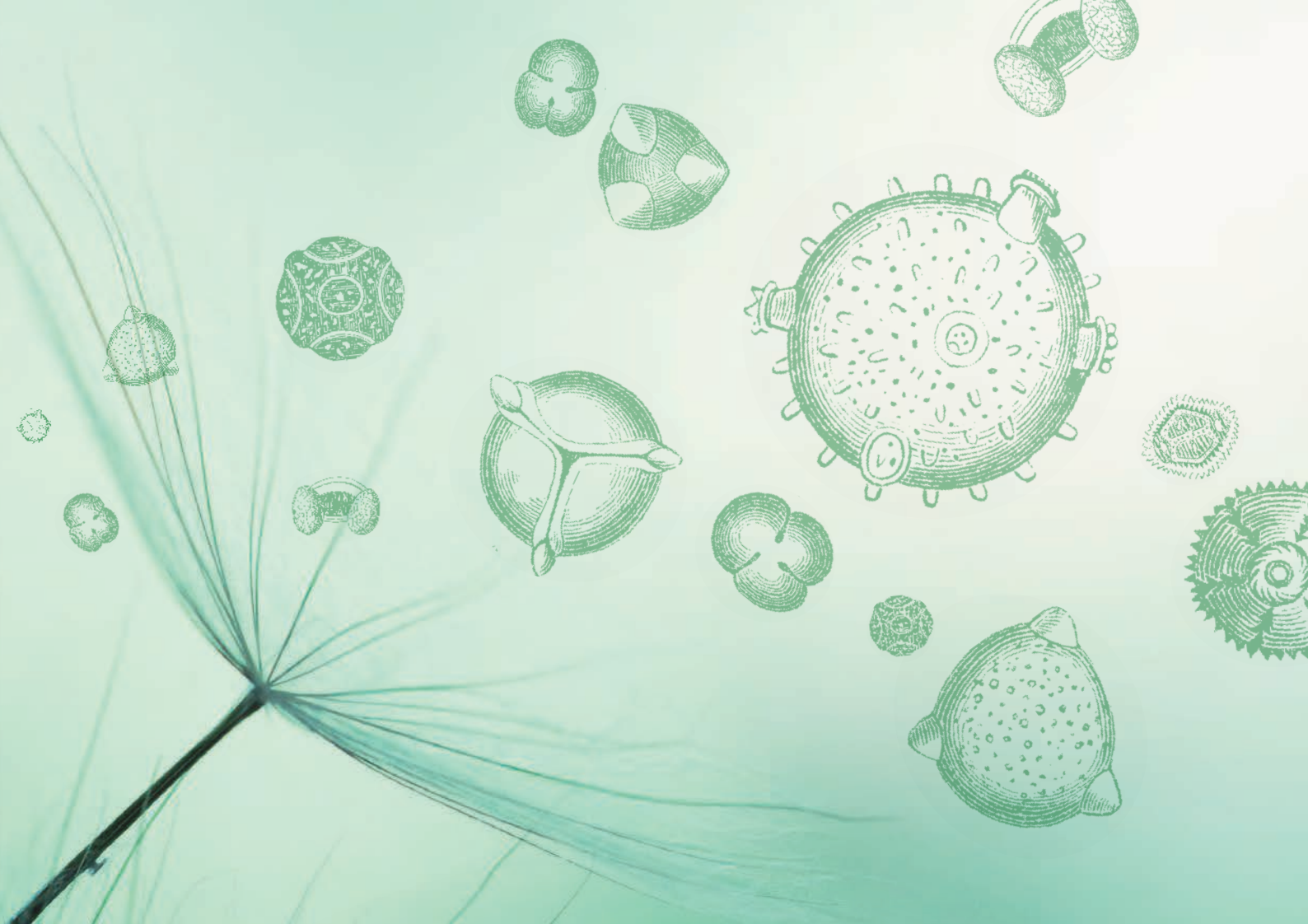

Studies predict that up to 50% of the population will be affected by pollen in the future. In addition, global warming and climate change are altering the flowering season and thus the periods of high pollen counts. "In milder winters, our monitoring showed hazel pollen already at the end of November. Normally, this pollen is expected in January," reports Dr. Jörg Haus, Product Management Instruments, Helmut Hund GmbH. Particularly ambrosia, which blooms from July to October, is a big problem for allergy sufferers. Its allergy potential is five times that of grass. "As few as 11 grains of pollen in one cubic meter of air are considered a heavy load." This can result in rhinitis, sensitivity to light, headaches, shortness of breath, or severe asthma. Imported plants can also turn into an unexpected problem, explains Dr. Haus: "Olive trees, which many people enjoy having on their balconies or terraces,

are very allergenic and are known to be the worst offenders in southern countries."

Delayed evaluation

This makes it all the more important to know when and which pollen are in the air and in what concentration. The standard used in many European countries is the so-called Burkhard trap. A defined volume of air is constantly drawn in by a fan from the current wind direction and guided past a slowly rotating drum. Affixed to this drum is an adhesive strip which the pollen and any other particles drawn into the drum stick to. The 14.4 m³ of air drawn in over the course of a day corresponds to what an adult at rest would breathe in. The adhesive strip must be replaced and analyzed after seven days at the latest. Then, with the aid of microscopes and a refer-

ence book for identification, trained pollen counters announce the result in around 2 to 3 days – sometimes, however, this can take up to several weeks. And because pollen change depending on the season and climate, errors can occur during analysis which lead to misclassification rates in the low double-digit percentage range. Nevertheless, this method remains the gold standard for counting pollen. The good thing is that relatively precise data is obtained in terms of pollen load and time on any given day. This data is then used to generate models for a region in a certain month or season. "Due to the way the system works, the data is at least two days old by the time it's available. This isn't much use to an allergy sufferer. If I'm planning an outdoor activity today because the sun's out or if I need to know whether or not to bring my asthma spray, 2-day old data from a day on which it may

have rained doesn't help," says Dr. Haus, summarizing the problem with the most commonly used methodology. "So we started to figure out how to make the process more intelligent."

Real-time pollen monitoring

In 2003, a prototype automated pollen analysis was developed in a collaboration between the University of Freiburg and the local Fraunhofer Institute. It was evident early on that this solution required electric drives, e.g. for transporting the sample carriers, focusing the camera, or for scanning. "The design of the prototype wasn't ideal and couldn't be commercialized. So we at Helmut Hund GmbH, in collaboration with a new partner, decided to turn this into a product ourselves."

The new partner for the Wetzlar-based company was the Fraunhofer Institute

for Applied Information Technology FIT in Sankt Augustin. The solution, the BAA500 pollen monitor, was developed in a joint effort. "BAA stands for bio-aerosol analyzer and combines our expertise in precision engineering, optics, and electronics," explains Dr. Haus. The device is air-conditioned and protected against weather, it can take between four to eight samples a day, with each sampling operation taking about three hours, and it works autonomously for up to six months. "The BAA500 enables us to provide a near real-time forecast as to which pollen are in the air and in what concentration."

To perform an analysis, the device draws in about 60 m³ of air per hour and extracts the pollen on sample carriers. Pollen look rather shriveled due to the impact of weather and drying. A layer of gel on the sample carriers plumps them up again and makes

them round. "This step alone requires a high degree of precision. An automatic analysis must be able to capture small differences in size or the interior structure," Dr. Haus points out. Pushers that are driven by FAULHABER DC-micromotors of the 1727... C series, then move the samples underneath a microscope between condenser and lens. A heating cartridge heats the gel slightly. Each sample is then scanned on three axes. "At 20 µm, pollen are tiny. They're about a quarter of the size of a human hair. The light microscope therefore sees an area of less than 0.5 by 0.5 mm in each photo. The depth of field is not that great because we need a high resolution," says the Microscopy Product Manager.

Intelligent image recognition

To identify the pollen, Hund uses the so-called stacking principle in which images are stacked with the help of software. This technique is also used by amateur astronomers, for example. This approach allows you to generate an overall image with an extended depth of field from several images of the image stack (each with a shallow depth of field). Then the individual pollen grains are identified by the software via a feature-based algorithm. The system is currently capable of identifying 38 types of pollen and other allergens, such as fungal spores. "Image recognition first has to be taught in, depending on local differences and weather conditions. That is why we keep thousands of images in the trunk. To be able to go outside, measure, and recognize automatically, you need as many examples and species as possible."

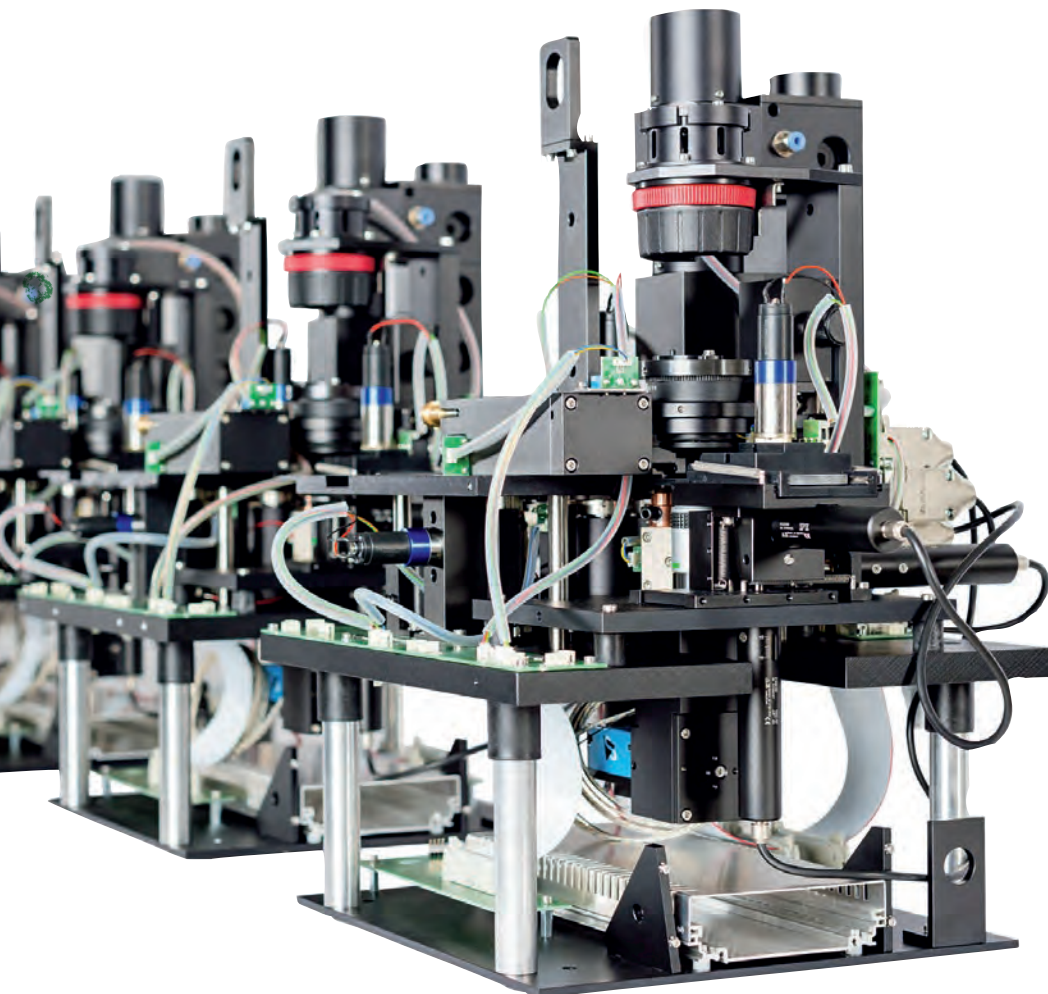

At the heart of the pollen monitor is the evaluation and analysis module

After analysis, the sample is transported into a magazine. This enables subsequent analysis and validation of the results, for example by scientists. In theory, this can take place months later. Analysis via the light microscope and the fact that the samples are retained make the BAA500 unique compared with other similar systems. Another FAULHABER DC-micromotor of the 1727...C series takes care of the necessary movement and precision during archiving.

"Ambrosia looks a bit like a spiky ball, pine looks like Mickey Mouse. That should be easy to distinguish, but it gets very challenging when you want to clearly tell apart adjacent early bloomers," explains Dr. Haus. Another problem are so-called varia, i.e. pollen which are still unidentified. These pollen are compared to the database, provisionally categorized, and then an operator checks and assigns the pollen. "This allows us to add new species, but also make corrections if a species looks different, for example in the cold spring of this year."

The real-time monitoring also produces very interesting findings. "Previously, aerobiologists assumed that there is no pollen in the air in cold weather. But our measurements showed that we had pollen in cold January."

Powerful network

The Free State of Bavaria was so impressed with the system that it began setting up an electronic pollen information network (ePIN) back in 2019. The locations were selected on the basis of a study by the Center for Allergy and Environment (ZAUM) at the Technical University of Munich and the research center Helmholtz Zentrum München. Various climate parameters and the population density were taken into account to optimally distribute the eight measuring stations. In addition to Munich, devices from Hund are now located in Garmisch-Partenkirchen, Feucht, Viechtach, Markttheidenfeld, Altötting, Mindelheim, and Hof. "The Bavarian Ministry of Health invested two million euros into this the world's first

electronic pollen information network. This is a good investment, because 50% of the two million allergy sufferers in Bavaria react to pollen," said Bavaria's Minister of Health Melanie Huml during the launch in 2019.

"The true power of these devices lies in networking," Dr. Haus believes, "you can make very precise predictions if you combine the data from the various pollen analysis stations and the weather data." There are a total of 20 devices in Berlin, Wetzlar, Leipzig and Wiesbaden in addition to the Bavarian ePIN locations. Choosing the right location is very important, as diesel soot or tire abrasion, for example, can impact the results. "It wouldn't make any sense to set it up in the middle of a rapeseed field where you only get rapeseed pollen. This is why we set up our measuring stations at a height of about 12 meters on the roofs of clinics or institutes."

The data can be retrieved in real-time around the clock online or via an app. Even medical practices or allergists like to use the service to optimally treat their patients. "Our device in Wetzlar is our test unit, and every time we want to try out a new function we have to shut it down. While carrying out such

The website of Helmut Hund GmbH shows the pollen information measured with the BAA500 in Berlin, Freiburg, Leipzig, Wiesbaden, Wetzlar, and Munich. The data for a month, a calendar week, or even individual days can be selected. The data can be retrieved here: <https://t1p.de/PIN>.



FAULHABER SERIES 1727...C
DC-MICROMOTOR



www.faulhaber.com/en/markets/precision-monitoring-measuring/
www.hund.de

Automation takes a lot of finesse

The test tube goes into the centrifuge, the component must be in its place, and the package belongs on the conveyor belt. In modern systems, "pick-and-place" is performed by automated grippers. These must be able to grip very gently when it comes to laboratory automation. Millions of times over, precisely and reliably – much like the new GEP2000 series from the Zimmer Group.

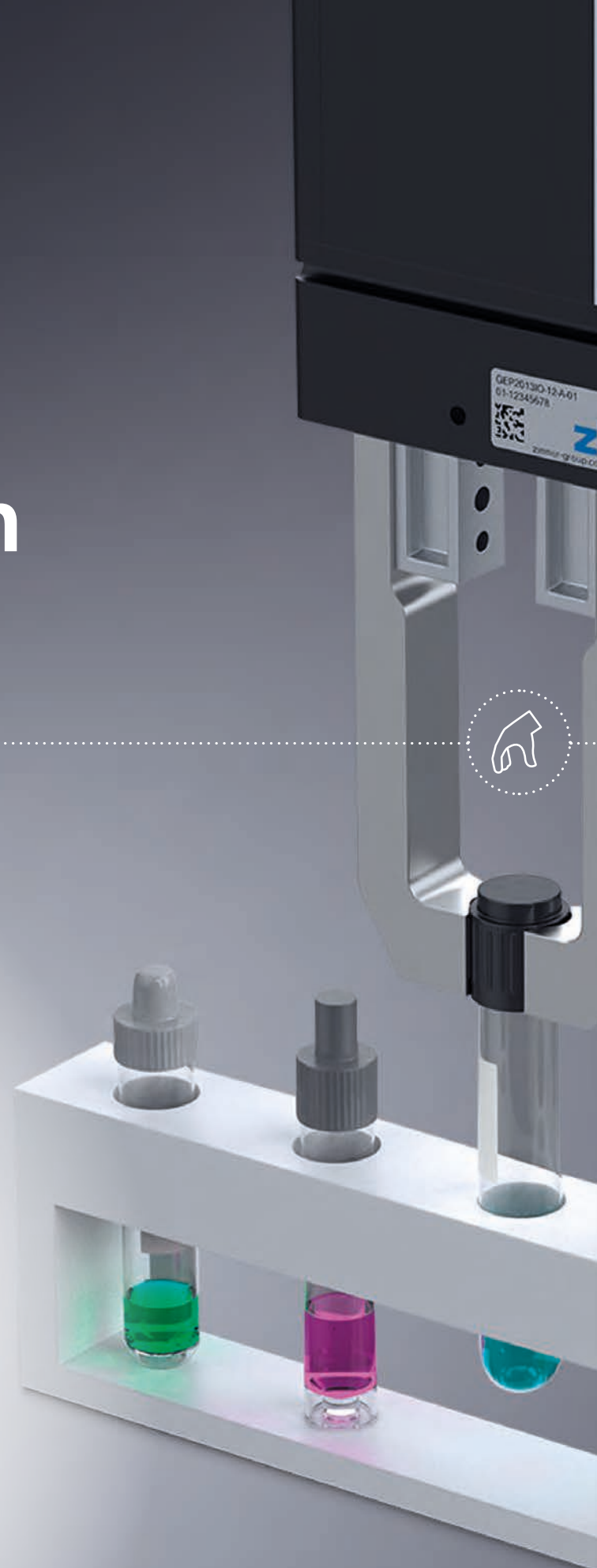



Testing and vaccines provide the way out of the coronavirus lockdown and a gradual return to normality. But the measures introduced by the authorities to contain the pandemic were quickly exhausted. Because the exponential spread of the virus led to a soaring global demand for tests and vaccines. In the beginning, the capacities were insufficient, and the wait for test kits and vaccines really put the patience of the world to the test.

Laboratory automation against Covid-19

The pharmaceutical industry, medical technology, and medical laboratories did actually work extremely quickly. This also applies to the expansion of production and to the increase of testing capabilities. A key factor in this success was automation. In laboratories, the pandemic proved to be a major impetus for automation. Automatic laboratory devices and universal, flexible robots can relieve specialists of a great deal of work and increase both throughput as well as efficiency. The automatic gripping and handling of samples, pipettes, or reagents is among the central, constantly recurring process steps here. For this purpose, delicate, industrial small parts grippers are required.



Two different technologies are generally available for gripping, explains product manager Maik Decker, who is responsible for this area at the south-west German manufacturer Zimmer Group: "Up until now, most grippers in industry have been powered pneumatically, i.e., with compressed air. This technology is, however, not suitable for the hygienic environments required in laboratories, in medicine and in the pharmaceutical and medical technology industries. Grippers with electric drive are therefore used in these areas."

Electric motor makes grippers flexible

In addition to the hygienic aspect, these grippers have another advantage: they function without a compressed air system and the associated lines. In some industrial sectors, these are standard equipment in production facilities – electricity is, after all, available everywhere. Besides, the machines in which the grippers are installed operate with electric power. An electrical connection is much easier to install than a compressed air supply. Moreover, the control of electric components is both simpler and more flexible than working with pneumatics. "We see a clear trend toward the electric drive, not least in the automotive industry," explains Maik Decker.

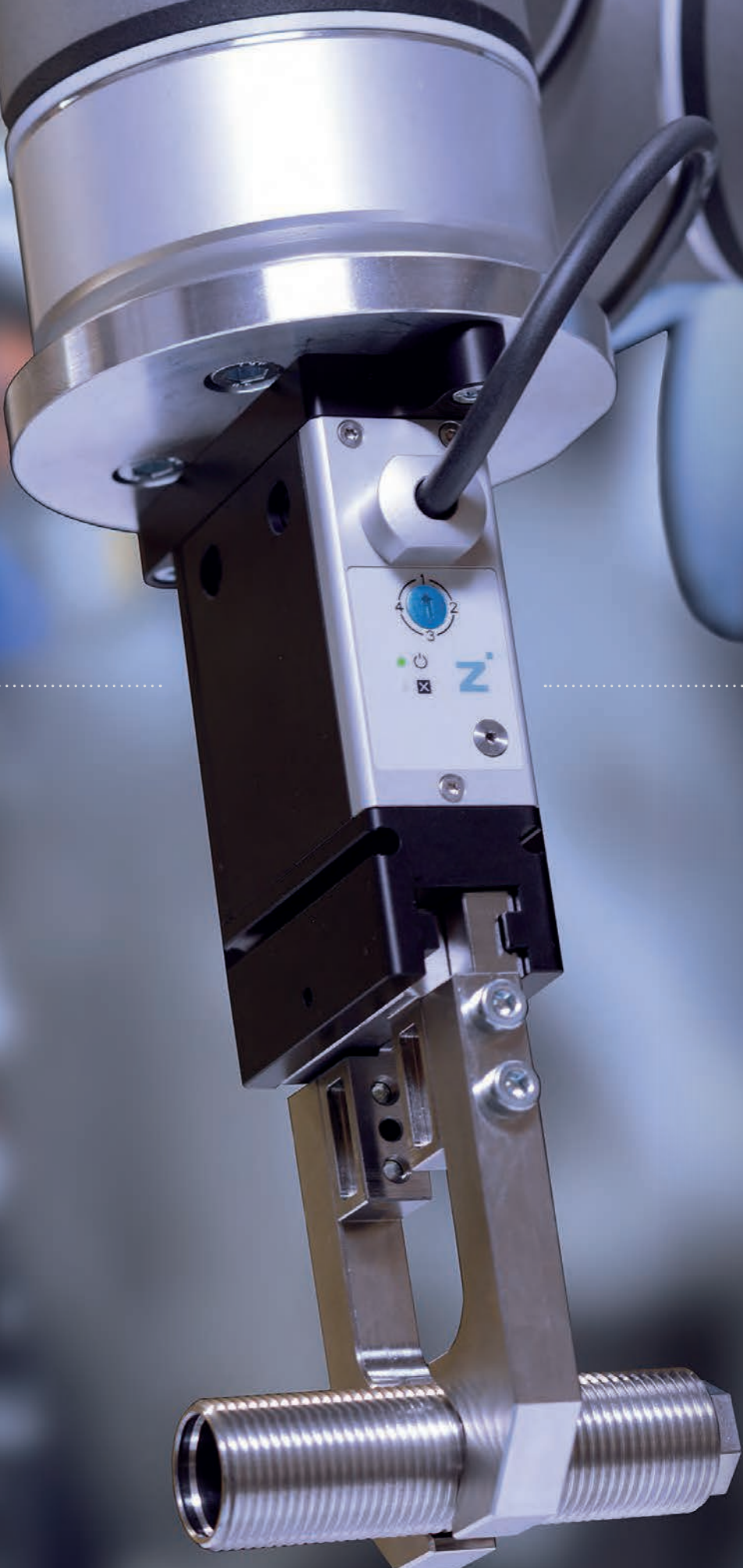

New products from the Zimmer Group, such as the new GEP2000 series, serve and consolidate this trend. The small parts gripper can – depending on the version – grip and hold components weighing up to five kilograms but can likewise handle delicate and sensitive parts such as a test tube without problem. "The advantages of the electric drive also include the ability to adapt the gripping force to various objects at any time," explains Volker Kimmig, team leader for software at the Zimmer Group. "With the appropriate controller, the gripper can switch between different parts during a running process."

10 million cycles without maintenance

The power for these work steps is supplied by a brushless DC-servomotor of the BX4 series from FAULHABER. In addition to a high torque, the strengths of the four-pole drive include its low vibration and low noise, compact design and a long service life. "We guarantee that this product will perform over 10 million cycles without maintenance," says Volker Kimmig. "This is, of course, only possible with a motor of very high quality." Such a motor must also provide a number of additional features to meet the demands of continuous operation in a typical pick-and-place application.

The development engineer uses the production of car keys as a good example: "Large quantities and high throughput set the tone here. The gripper robots work under very high-paced, permanent stress with short cycle times. The motor must therefore start and then stop again at very short intervals. Decisive here is the motor's acceleration, as every tenth of a second counts in the process as a whole. Moreover, the motor needs to be able to efficiently dissipate the heat that forms in such an operation in order to eliminate the possibility of overheating."



Proven collaboration

The gripper experts from the Zimmer Group knew, not only from the data sheet, that the BX4 from FAULHABER would satisfy these requirements. They had previously installed motors of this series in their GEH6000 gripper family. Essentially, this so-called long-stroke gripper works in the same way as the small parts gripper. Its stroke, i.e., the distance between the open and closed position of the gripper jaws, is significantly larger and can be up to 80 millimeters.

"The device can thus cover a wider range of different-sized target objects in the same process," explains Maik Decker. "The smaller GEP2000, on the other hand, can also perform its work in very confined conditions. Of course, this only functions with a motor that delivers very high power in a very small space."

Mechanical self-locking

The gripper series have one special feature in common with other Zimmer Group products: The motor power is transferred to the jaws by a worm gear drive with a steep pitch. Even in the event of a power failure, the gripping force is retained and the respective

position held. Once gripped, a work piece is held securely by this mechanical self-locking function, without an additional device such as a brake being required.

The drive electronics in the two gripper types operate slightly differently. With the GEH6000, the encoder signals of the drive are used for positioning the jaws; with the GEP2000, this task is performed with the help of a positioning sensor. Both solutions achieve a very high degree of repeatability: the specified path of the jaws is reproduced to within one five hundredths.

"In many applications, the prepositioning when lowering the gripper to the target object is very important," explains Volker Kimmig. "In constrained spaces, the open position is often only allowed to be very slightly larger than the closed position. When "maneuvering" a robot arm in a complex environment, it may also be necessary to make very precise presettings. We do this using very precise electromechanics, where the motor once again plays a crucial role, as well as with a flexible data connection. Our devices can be equipped with IO-Link and with digital I/O. This makes it easy for them to move in and back out again just about everywhere."



FAULHABER BX4
BRUSHLESS DC-SERVOMOTORS



www.faulhaber.com/en/markets/medical-laboratory-equipment/
www.zimmer-group.com/en/

TIME FOLLOW

A wristwatch that "sleeps" when you take it off and wakes up when you put it back on? The Type 2 from Ressence surprises in the world of mechanical timepieces with innovative functionality and revolutionary product design.

It is a unique mechanism in the world of mechanical timepieces: The watch "sleeps" when it is set down and wakes up again when picked up from the nightstand. The correct time is set automatically. In yet another unique feature, it is not the hands that move, but instead the very unusual dial of Type 2 from Ressence. This fascinating animation is powered by the smallest series motor from FAULHABER.

What would a mechanical watch look like if it was reimagined and redeveloped from the bottom up? Benoît Min-tiens asked himself this question about twelve years ago. At the time, the product designer worked as a consultant and was involved in a wide range of design processes: "As a generalist, I worked with many different things. The spectrum ranged from hunting rifles to aircraft cabins – a very interesting job! But I wanted to finally develop something myself again and design an entire product new from the bottom up."



A close-up photograph of a watch dial. The dial is dark with light-colored hour markers and numbers. There is a date window at the 3 o'clock position with a small orange hand. A small seconds sub-dial is located at the 6 o'clock position. The watch has a metal case and a dark, textured strap. The background is a dark blue gradient with three white circles.

VS FUNCTION

Up to that point, the Belgian had had nothing at all to do with watches. His decision to move to this industry was strategically considered. The watch – unlike a car, for example – is a clearly defined product. A large team is not required for conception and development. At the same time, aspects such as design and innovative technology play an important role for the buyers of first-class chronometers. It is precisely this clientele that Benoît Mintiens wanted to appeal to with his new development.

Prototype instead of old-timer

Instead of buying an old-timer, which he had saved for, he invested 30,000 euros in the project, 10,000 of which went towards a small exhibition booth at the world's most important trade show for watches in Basel. In 2010, he presented the first three prototypes of his watch there, for which he had newly designed all parts on a computer. "The greatest challenge at the start was to have the parts produced with the necessary precision at an affordable price," recalls the company founder. "With such small quantities, that is no easy task."

He used intermediate products for purposes other than those intended: For the axes, pieces of sewing needles were used that are manufactured with high precision and have a very smooth surface; used as sleeves were the canulae of disposable syringes, which just happened to be a perfect fit for the needles. For the development work, Mintiens purchased the inventory of a neighboring pharmacy. "My wife then told me that the pharmacist took her to the side and, in a concerned tone, informed her of my unusual purchases," explains the designer with a grin.

Lever instead of crown

Even though the prototypes could not be perfect under such conditions, his innovative watch concept was met with a great deal of interest in Basel. With the preorders that he went home with, he was able to start series production and could now also afford to pay the highly specialized parts suppliers of the Swiss watchmaking industry.

The basis of his success was – and is – an entire series of unique features that can be found only in watches from Resence. They differ from the products of the competition already at the first glance: It is not the hands that move on the dial but instead the dial itself. To be precise, there are multiple dials – a different one for each hand: the smaller hands are integrated in the large hand – and circle one another like a planetary gearhead and are constantly seen in new constellations. In spite of the unusual picture that forms as a result, one intuitively recognizes the big and small "hands" as the markers for minutes and hours.

Also missing is the crown, the small dial on the side which, on other mechanical watches, is pulled out and used to set the time. Its function is performed by a hinged lever on the bottom of the watch. The initial winding is also performed with the mechanical movement for the setting of the time. From

that point on, an automatic movement ensures spring tension and accuracy.

Time signal plus motor drive

With the help of an accelerometer, the Type 2 also recognizes whether it is currently being worn or if it has been set down. In the latter case, the spring energy is conserved and the movement paused; the dials stop moving. In addition to the mechanical movement, this model also has on-board electronics called an "e-Crown". When first set, it saves the time and continues to measure the time during the rest phases. The sensor registers when the watch is again put on, and the electronics release the spring. The movement is

started by double-tapping the bezel, and the correct time is then automatically set – even if the watch has not been worn for months.

"With the e-Crown, we expand the concept of the mechanical watch with a new dimension," says Benoît Mintiens. "The correct time is always available, and a person can also select a second time zone that the watch then likewise automatically sets. For the selection of the zone, the electronics communicate via Bluetooth with an app developed specifically for this purpose. Nevertheless, the watch remains



- 01 Communication Center
- 02 Energy Cell
- 03 Energy Management
- 04 Kinetic Energy Input
- 05 Seconds hand zero-setting
- 06 Micro Motor
- 07 Touch sensor
- 08 Setup Management
- 09 Micro Gearbox
- 10 Mode selector
- 11 Hand position Reader

an independent unit thanks to its automatic movement; the electronics do not interfere with its actual function. The electronics are only used for the adjustment steps that are otherwise performed with the crown."

The e-Crown consists of 87 components; its flexible PCB with four layers is just a quarter of a millimeter thick. All parts are of the smallest dimensions and optimized for minimum energy consumption. As a result, the watches get by on just 1.8 joules of energy per day. The electronics check the position of the dials at least once per day

and make a correction if necessary. As occurs when putting the watch on again or when switching between the time zones, an automatic adjustment process is triggered.

Micro-powerhouse

During this process, the large and small dials are turned to the appropriate positions. The power for the mechanical work of the e-Crown comes from the smallest series motor from FAULHABER, the 0308...B brushless DC-servomotor, in combination with the 03A micro planetary gearhead. With a diameter of just three millimeters, the drive unit fits in the extremely

small installation space present in the watch. In addition to the space, the available electric power is also quite limited there.

It flows from six micro-lithium-ion batteries, which are charged by likewise very small solar cells. They supply just 1.2 volts. "This is actually not enough to overcome the intrinsic inertia and friction of the system," explains sales engineer Hein Vos from FAULHABER Benelux. "We therefore made a number of changes to the gearhead. These include a modified shaft, an adapted gear ratio and a special lubricant."

The connection between Ressence and FAULHABER arose through the recommendation of another supplier, recalls Benoît Mintiens. There may certainly have been other products that would have been small enough for his watch. But, after looking more closely, the choice was not difficult and was clear: "One expects that a mechanical watch will function flawlessly for decades. With the Type 2, this holds true, of course, for the e-Crown as well. The technology from FAULHABER guarantees the high quality and reliability of the drive that I need."

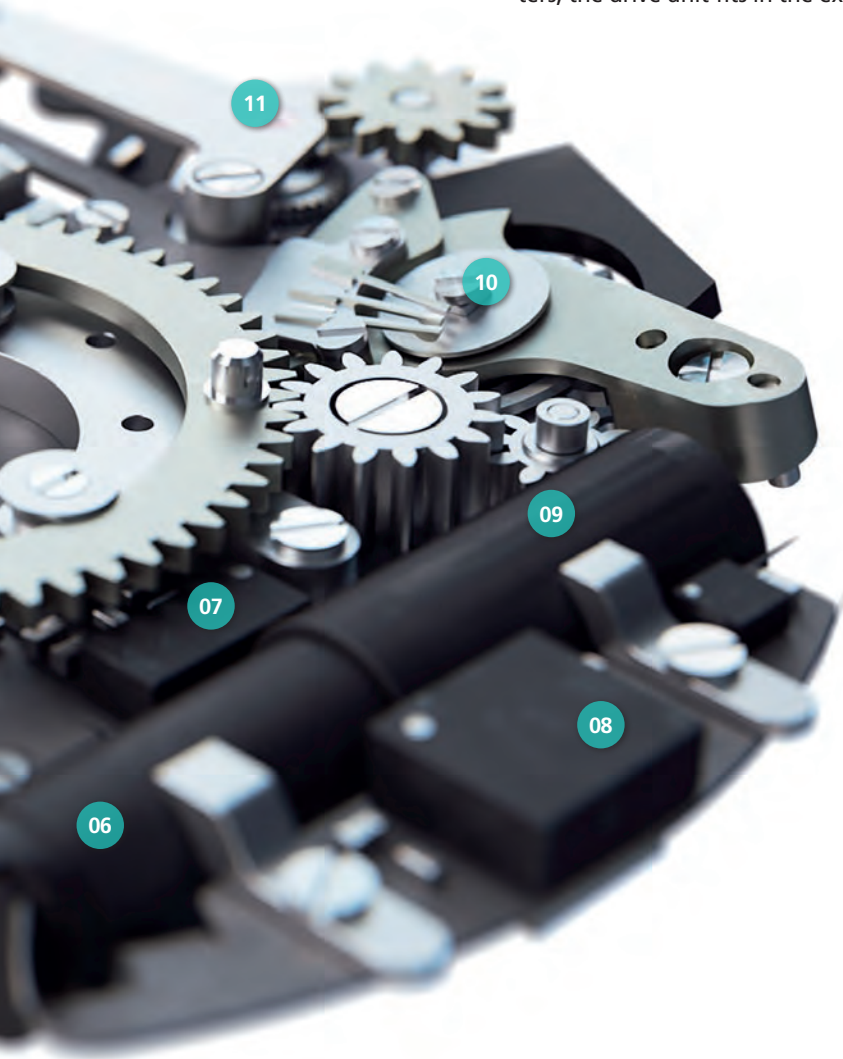

FAULHABER B-MICRO
BRUSHLESS DC-SERVOMOTORS
2 POLE TECHNOLOGY, SENSORLESS



www.faulhaber.com/en/markets/consumer/
www.ressencewatches.com/watches/type-2

Driving sustainable growth

The protection of our climate is a challenge for humanity – something that FAULHABER is all too aware of and in 2020 became one of the first companies in Germany to achieve CO₂ neutrality in production. With this and other measures, the drive specialist puts the topic of sustainability at the center of its business activities and planning.

Sustainability is a core value of the FAULHABER. Careful handling of resources and the reduction of harmful emissions are, therefore, key elements of

the corporate management. FAULHABER technology is already making a contribution to responsible and sustainable handling of natural resources by develop-

ing drive systems with a high degree of efficiency and low energy requirements. In order for us to preserve the abundance of natural ecosystems for future



150⁺

JobRad bikes to promote sustainable mobility

-100%

All production sites CO₂-neutral

CO₂

generations, FAULHABER has set itself the goal of achieving sustainability in all of its facets and is acting accordingly. The drive specialist is aware of its responsibility towards future generations and is thus making sustainability a cornerstone of its corporate mission statement.

Package of measures

In 2020, FAULHABER became one of the first production companies in Germany to achieve CO₂ neutrality – this now applies to all production sites. Not only are the CO₂ emissions generated during production offset through the company's participation in climate protection projects, but also emissions that arise during business trips by car, plane or other means of transport.

FAULHABER is committed to the continuous improvement of its environmental impact. That is why the drive specialist has also been using CO₂-neutral logistics since 2015.

Through the implementation of various measures, such as solar roofs at various production sites, we have been able to achieve a 12% increase in the proportion of the electricity requirement covered by our own, regenerative sources. It is our declared goal to continuously improve this share.

At the Schönaich location, FAULHABER is working with JobRad to reduce the CO₂ emissions of its employees from and to work. Switching from car to bicycle makes a significant contribution to the company's climate neutrality. Over 150 JobRad contracts have so far been concluded. The company's CO₂ footprint has also been improved through the introduction of home office and the resulting reduction in commuting.

It is our declared goal and commitment to constantly improve our life-cycle assessment. Serving as a yardstick for us here is compliance with the requirements of ISO 14001, which is met by all locations as a minimum. In this regard, we regularly evaluate the state of our environmental management system.

We examine the technical and organizational procedures and processes to identify possible weak points and take all necessary measures for avoiding harmful environmental impacts from our activities and products. Through consistent recycling, the careful use of energy sources and raw materials as well as a reduction of the environmental impact, we make an important contribution to conserving the environment and resources," says Jörg Rittker, FAULHABER Environmental Management.

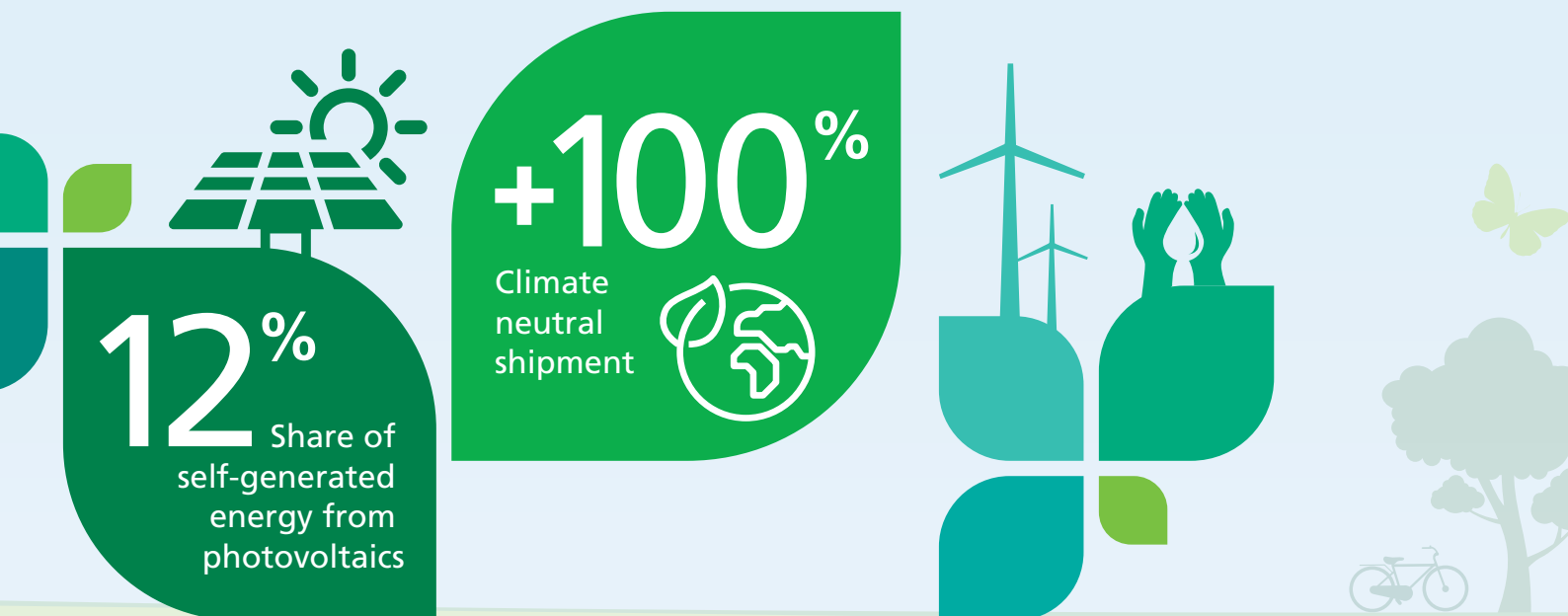

BOOK RAFFLE

Where do you read 'motion'?



To mark the publication of the specialist book "Elektromagnetische Verträglichkeit von elektrischen Kleinantrieben" (Electromagnetic compatibility of electric miniature drives), we are launching a competition in which you can win the book by Dr. Andreas Wagener. How do I take part? Send us a photo showing how and where you read 'motion'. At home, in the staff restaurant, on the train or simply at the office? We look forward to receiving your creative, funny or unusual entries. We will be giving away 5 copies of the book. Please send your photo to redaktion@faulhaber.com

Send us your photo and win!



Learn more about the new EMC reference book at www.faulhaber.com/en/news-events/news/



Ident-Nr. 000.9222.21

Further information:



faulhaber.com



faulhaber.com/facebook



faulhaber.com/youtubeEN



faulhaber.com/linkedin



faulhaber.com/instagram

FAULHABER motion is also available in digital format:

