

Drive Systems





The cornerstone and quality seal of FAULHABER drive technology is the self-supporting, coreless rotor coil with skew-wound design developed by Dr. Fritz Faulhaber

WE CREATE MOTION

We create motion

We are an independent, family-run group of companies. Our head office is in Schönaich (Germany) in one of Europe's most important regions for advanced industrial technologies. Founded in 1947, FAULHABER today boasts the largest range of highly developed miniature and micro drive technology which is available worldwide from a single source. As an international, innovative network with over 2 300 employees worldwide, we harness our power of diversity in order to provide our customers with drive solutions that are optimally designed to meet their specific needs. Drive solutions for markets in which precision and reliability in the smallest of spaces are decisive.

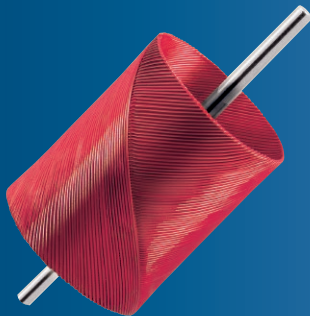



Special connectors, lubrication, flanges, shafts or configuration for a specific operating point – all series can be modified in a multitude of different ways and in an uncomplicated manner

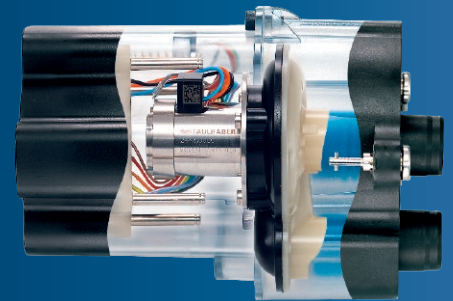

Custom-made to be optimally configured and designed for the application concerned – some drive solutions from FAULHABER consist completely of customer-specific components



Motors, gearheads, encoders, linear components, drive electronics – all of the products in the FAULHABER standard range are perfectly adapted to each other

From standard to custom solution

From the powerful DC motor with a continuous torque of 200 mNm to the filigree micro drive with an outer diameter of 1,9 mm, the FAULHABER standard range can be combined in more than 25 million different ways to create the optimum drive system for a particular application. At the same time, this technological „construction kit“ is the basis for modifications which allow us to configure special versions to meet the specific needs of customers. High-performance engineering and extensive application expertise also make us a valued partner for the development and production of customer-specific drive solutions. The solutions range from special components specially designed for the application to system partnership with automated production for complex mechatronic assemblies.



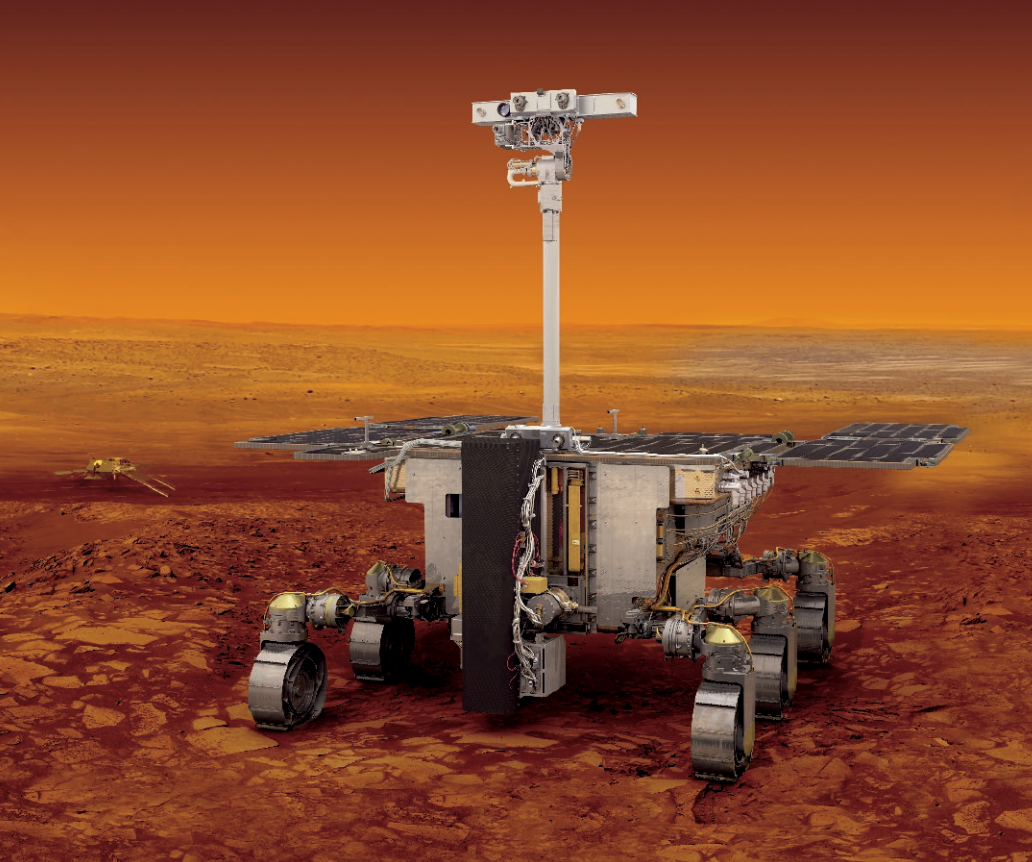

AEROSPACE

In space or in civil aviation – the components used in this environment are subjected to extremely high mechanical stress. FAULHABER drive solutions function reliably in a vacuum and at extremely low temperatures, or ensure safety and comfort for air travel.

ROBOTICS

FAULHABER's industrial-grade drive components convince with their performance dynamics and torques in combination with a robust and compact construction. They are ideal both for precise and highly dynamic positioning applications or for delicate and low-noise movements.



FACTORY AUTOMATION

Various actuators and sensors are integrated in automated manufacturing applications. The linking together of these components and the commissioning of the systems must take place simply and quickly. FAULHABER drive systems can be configured conveniently.



WE CREATE MOTION

Applications in cutting-edge markets

MEDICAL SCIENCES AND LABORATORY TECHNOLOGY

The tasks of analytical devices and machines used in laboratories are becoming increasingly sophisticated. Precision and speed are important requirements despite the compact dimensions. FAULHABER with its wide variety of dynamic miniature and micro drives offers custom-made solutions.



OPTICS AND PHOTONICS

Adjusting optical lenses for zooming and focusing or the adjustment of mirrors in laser applications require maximum precision in the smallest possible installation space. Here, FAULHABER drive systems provide full functionality in compact form.

INDUSTRIAL MACHINES

Industrial machines are becoming ever more complex with regard to functionality and design, while their size remains the same. FAULHABER motion control systems provide the full range of functions of complete positioning systems with minimum space.

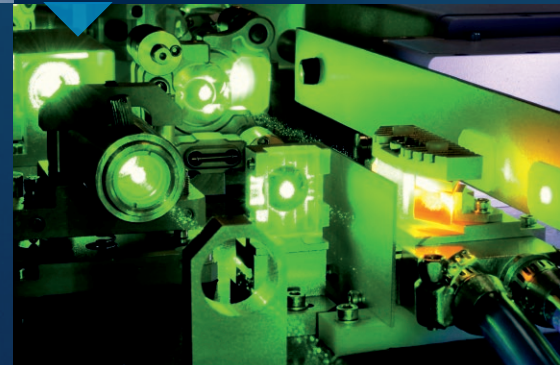
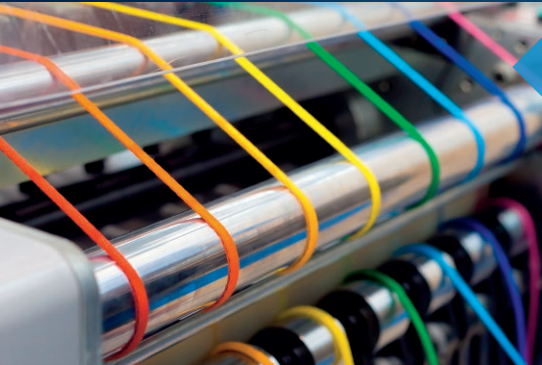



WE CREATE MOTION

We convince with innovative strength and partnership

It is our philosophy to always be technologically ahead by a nose length. We are pioneers, look beyond the horizon and constantly further develop our high-performance base technologies with focus on future requirements. We operate at the limits of what is technically possible. In doing so, we strategically invest in research and development as well as in modern process and production technologies in order to time and again set new standards with innovative products. The requirements and wishes of our customers are the central driving force. The basis for trustful and successful cooperation is dialogue. By means of continuous exchange between ourselves and our customers, it is possible to fully understand specific requirements and problems and to jointly and efficiently provide solutions. With employees who dedicate themselves to this task with commitment, experience and, in particular, a sense of responsibility.



We stand for excellent quality and added value

Around the world, the name FAULHABER stands for excellent products and the outstanding service. We have an uncompromising awareness for quality – supported by all employees – to thank for this outstanding position. Our global production network with harmonised international process standards creates synergy effects for competitive production and optimum availability of our products, and in the long term will ensure our quality awareness and maximum value for our customers. Conscious of our responsibility to future generations, our sustained environmental management programme is making an important contribution to protecting the environment and saving resources.



Our commitment and determination to continuously improve our services, structures and processes secures our international competitiveness and the satisfaction of our customers for the long term

WE CREATE MOTION



The success of our products and services is based on the commitment of our employees. Because their drive and their motivation are behind every FAULHABER drive

With regular ISO certification, we guarantee the fulfilment of international standards and profit from an outside perspective of our structures and processes. You can find the most current ISO certificates as well as documents on the conformity of the FAULHABER product line with respect to the currently applicable directives and regulations in the Support area of our website



DC-Motors

DC-Micromotors

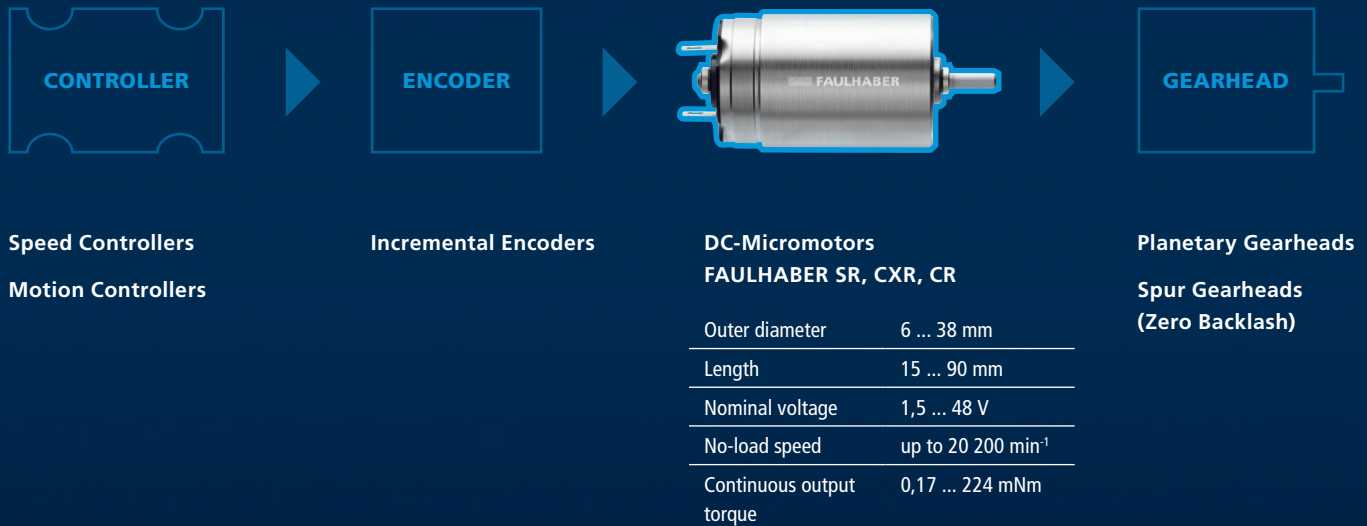



Originally invented by Dr. Fritz Faulhaber Sr. and patented in 1958, the FAULHABER coreless (or ironless) progressive, self-supporting, skew-wound rotor winding is at the heart of every FAULHABER DC-Micromotor.

This revolutionary technology created new possibilities for customer application of DC-Motors where the highest power, best dynamic performance, in the smallest possible size and weight are required.

Features and benefits

No cogging torque · Smooth position and speed control · High efficiency · Low Noise · High torque · Low Weight · Very low rotor inertia · Dynamic start-stop operation



Application examples: Panoramic camera head · Unmanned ground vehicle

DC-Motors

Flat DC-Micromotors and DC-Gearmotors



Speed Controllers
Motion Controllers

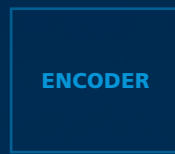

Incremental Encoders

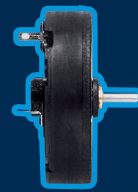

Flat DC-Micromotors
FAULHABER SR-Flat

| | |
|--------------------------|--------------------------------|
| Outer diameter | 15 ... 26 mm |
| Length | 5,5 ... 21,5 mm |
| Nominal voltage | 3 ... 24 V |
| No-load speed | up to 15 500 min ⁻¹ |
| Continuous output torque | 0,4 ... 100 mNm |

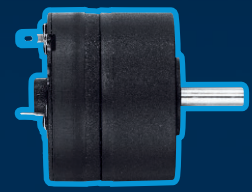

DC-Gearmotors
FAULHABER SR-Flat



FAULHABER Flat DC Micromotors are based on a unique, axial air-gap, self-supporting, ironless rotor winding which provides all the advantages of a traditional coreless DC micromotor but in a very thin package.

There are a wide variety of reduction ratios available in the same compact housing design. Integrated incremental encoders are also available for speed and position control.

Features and benefits

No cogging torque · Smooth position and speed control · High efficiency · Low Noise · High torque · Low Weight · Very low rotor inertia · Dynamic start-stop operation · Low torque ripple and EMI

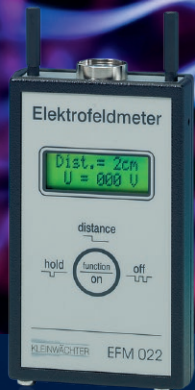

Application examples: Sewer robot ·
Portable electro field meter

Brushless DC-Motors

Brushless DC-Servomotors

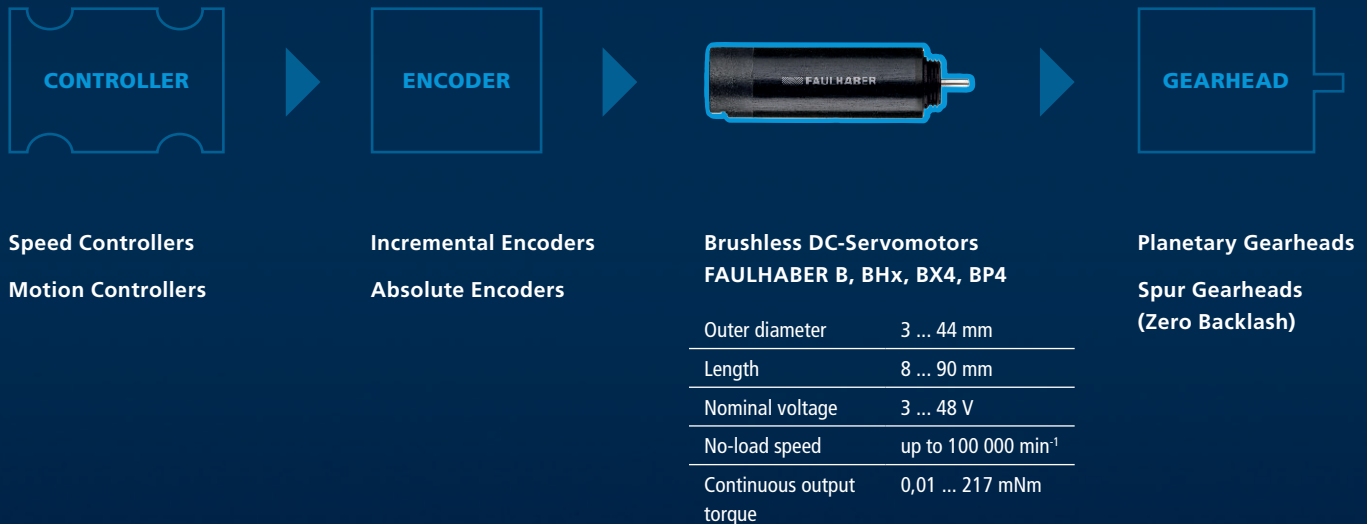



FAULHABER Brushless DC-Servomotors are designed for demanding applications where compact size and high performance are key. They are available in high torque 4-Pole or high power 2-Pole versions.

FAULHABER specializes in compact functional integration and many motors are available with integrated drive electronics, encoders, and analog hall sensors.

Features and benefits

High efficiency slotless design · High-torque or high-speed with small size and low weight · Highly dynamic acceleration and deceleration · Low noise · Available with a wide range of sensor options or sensorless

Application examples: Surgical robot · Electrical small parts gripper



Brushless DC-Motors

Brushless DC-Flat micromotors and
Brushless DC-Gearmotors

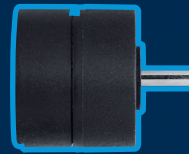
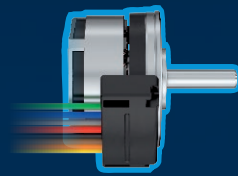

Speed Controllers

Brushless DC-Flat micromotors
FAULHABER BXT, B-Flat

Brushless
DC-Gearmotors

| | |
|--------------------------|--------------------------------|
| Outer diameter | 15 ... 42 mm |
| Length | 9 ... 22 mm |
| Nominal voltage | 6 ... 48 V |
| No-load speed | up to 15 000 min ⁻¹ |
| Continuous output torque | 0,5 ... 134 mNm |

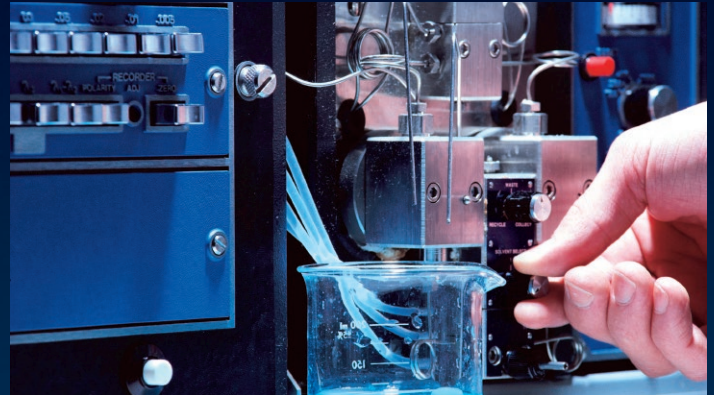

Application examples: Laboratory diagnostics · Sample distribution system

FAULHABER Flat Brushless Micromotors are based on innovative ironless coil designs that not only make them the flattest motors available in the industry but provide for smooth performance in a compact high efficiency package.

These motors are characterized by their excellent speed control, whisper quiet performance, and extremely low weight.

The innovative FAULHABER BLDC Gearmotors are also available with an extremely compact integrated spur gear-head for speed reduction and a significant increase in the available output torque.

Features and benefits

Ironless design · High efficiency · Precise speed control · Flat, light and extremely compact

Motors with integrated Electronics

Integrated Speed Controllers



**Brushless DC-Motors
with integrated Speed Controller
FAULHABER BRC, BX4 SC, BXT SC, B-Flat SC**

Planetary Gearheads

| | |
|--------------------------|--------------------------------|
| Outer diameter | 15 ... 42 mm |
| Length | 10,4 ... 85,4 mm |
| Nominal voltage | 6 ... 24 V |
| No-load speed | up to 16 800 min ⁻¹ |
| Continuous output torque | 1,9 ... 100 mNm |

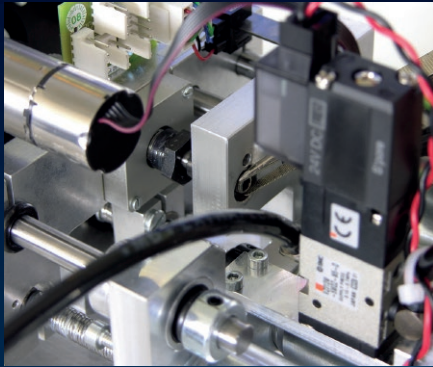

These brushless DC motors combine the advantages of a slotless brushless motor with dedicated, high precision, speed control electronics.

Speed control is achieved using the on board PI controller with an external command voltage.

Features and benefits

Integrated drive electronics · Extremely compact · Very robust construction · Easy to use · Integrated current limiting · Control parameters can be tuned to the application

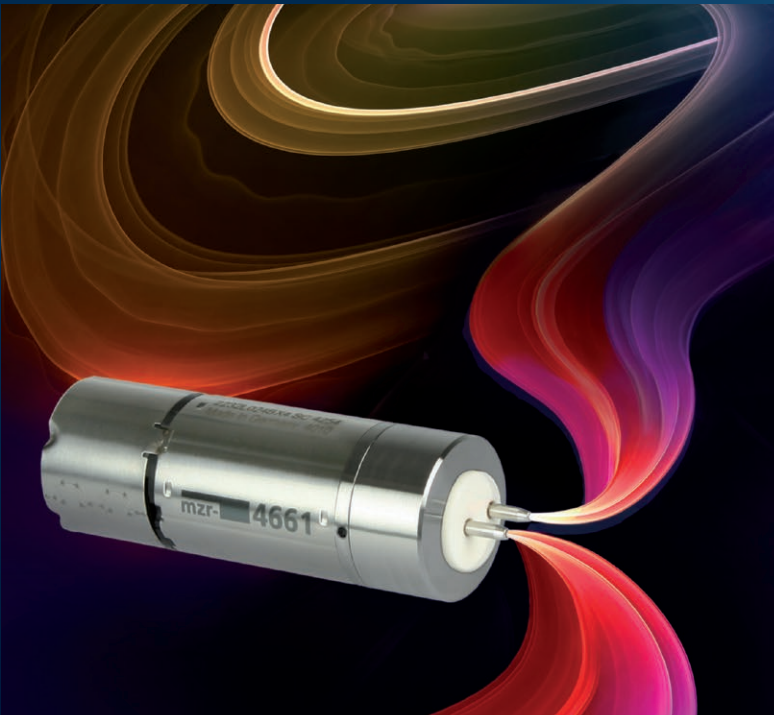
A photograph of a single brushless DC motor, model mzf-4661, set against a background of vibrant, flowing, multi-colored ribbons in shades of orange, red, and purple. The motor is silver and black, with a white label that reads "mzf-4661".

Application examples: Stripping machine · Micro annular gear pump

Motors with integrated Electronics

Integrated Motion Controllers



Motion Control Systems FAULHABER B Cx, BX4 CxD, MCS

Outer diameter $\varnothing 22 \dots \square 40 \times 54 \text{ mm}$

Length 49,6 ... 110 mm

Nominal voltage 24 V

No-load speed 5 ... 11 000 min⁻¹

Continuous output torque 16 ... 160 mNm

Planetary Gearheads

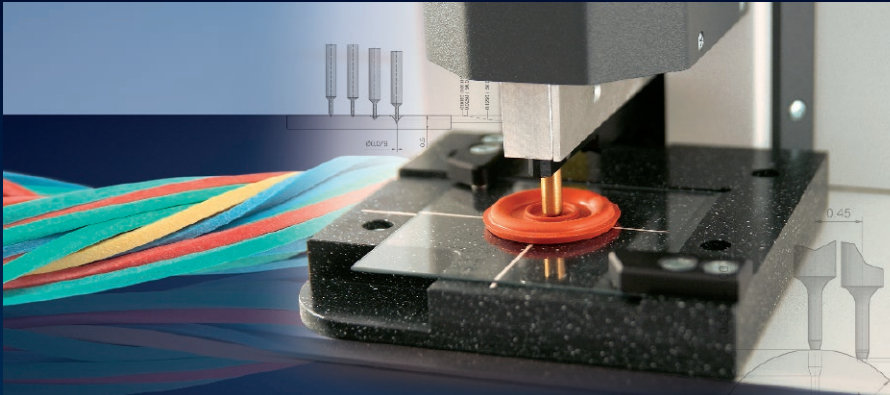

FAULHABER Integrated Motion Controllers combine high performance single axis motion controllers with the benefits of FAULHABER Brushless DC Servomotors to provide the industry's largest portfolio of integrated motor controllers.

Whether configured as stand-alone positioning drives or integrated into a multi-axis EtherCAT or CANopen network, FAULHABER provides customers with the most compact and simplest solution.

Features and benefits

Compact design · Wide speed range · High torque · Simple cabling · Low EMI between motor and controller · RS232, USB, CANopen and EtherCAT interfaces · Easy configuration · Many standard operating modes



Application examples: Nano-Shore durometer · Laser welding robot

Stepper Motors



Motion Controllers

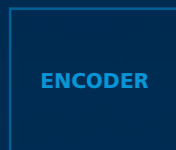

Incremental Encoders



Stepper Motors



Planetary Gearheads

**Spur Gearheads
(Zero Backlash)**

| | |
|--------------------------------|-------------------------------|
| Outer diameter | 6 ... 66 mm |
| Length | 9,5 ... 32,6 mm |
| Number of steps per revolution | 20/24/48/100/200 |
| Holding torque (boost) | 0,25 (0,39) ... 307 (581) mNm |

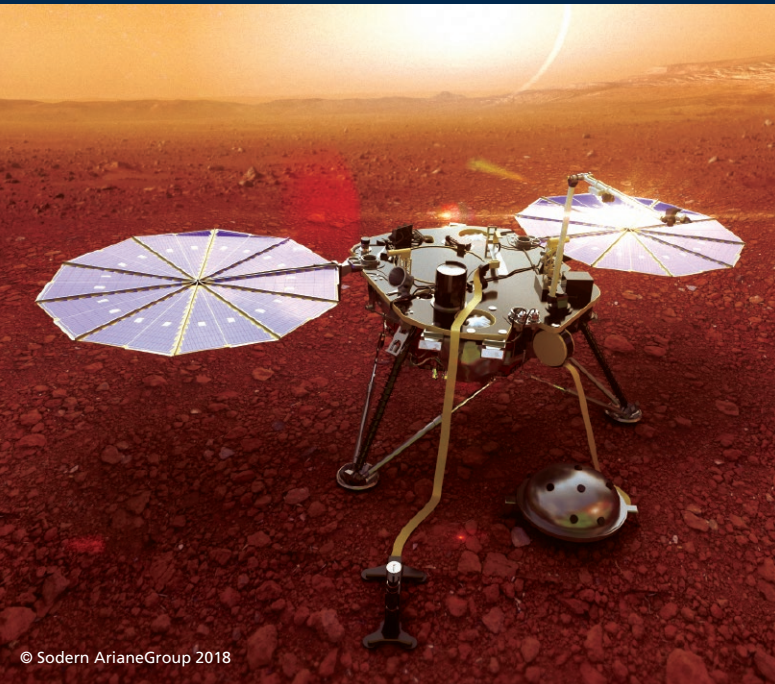

Robust assembly, high speed range, and exceptional performance in even the harshest environments make FAULHABER drive systems the perfect solution for demanding positioning applications.

They are available with a wide variety of modular servo components like encoders, zero backlash gearheads, integrated lead screws and much more.

Features and benefits

Extremely low rotor inertia · High power density · Long operational lifetimes · Wide operational temperature range · Ideally suited for micro-stepping applications

Application examples: Camera platform for reconnaissance drones · Seismometer for Mars mission

Linear DC-Servomotors



Motion Controllers

Linear DC-Servomotors

| | |
|---------------------------|-------------|
| Motor Length (w/o rod) | 8 ... 20 mm |
|---------------------------|-------------|

| | |
|-------------|----------------|
| Motor Width | 33 ... 85,5 mm |
|-------------|----------------|

| | |
|---------------|---------------|
| Stroke length | 15 ... 220 mm |
|---------------|---------------|

| | |
|-------|-----------------|
| Speed | 1,8 ... 3,4 m/s |
|-------|-----------------|

| | |
|------------------|----------------|
| Continuous force | 1,03 ... 9,2 N |
|------------------|----------------|



Linear DC-Servomotors bring linear motion to new dimensions. These high performance, miniature, linear motors consist of a solid stator housing and coil assembly and a multi-pole magnetic force rod.

High power magnets help the motor achieve its excellent force and dynamic speed performance.

Features and benefits

High dynamics · Excellent force to volume ratio · No residual force present · Non-magnetic steel housing · Compact and robust construction · No lubrication required · Simple installation and configuration



Application examples:
Linear positioning systems ·
Microscope scanning stage

Precision Gearheads

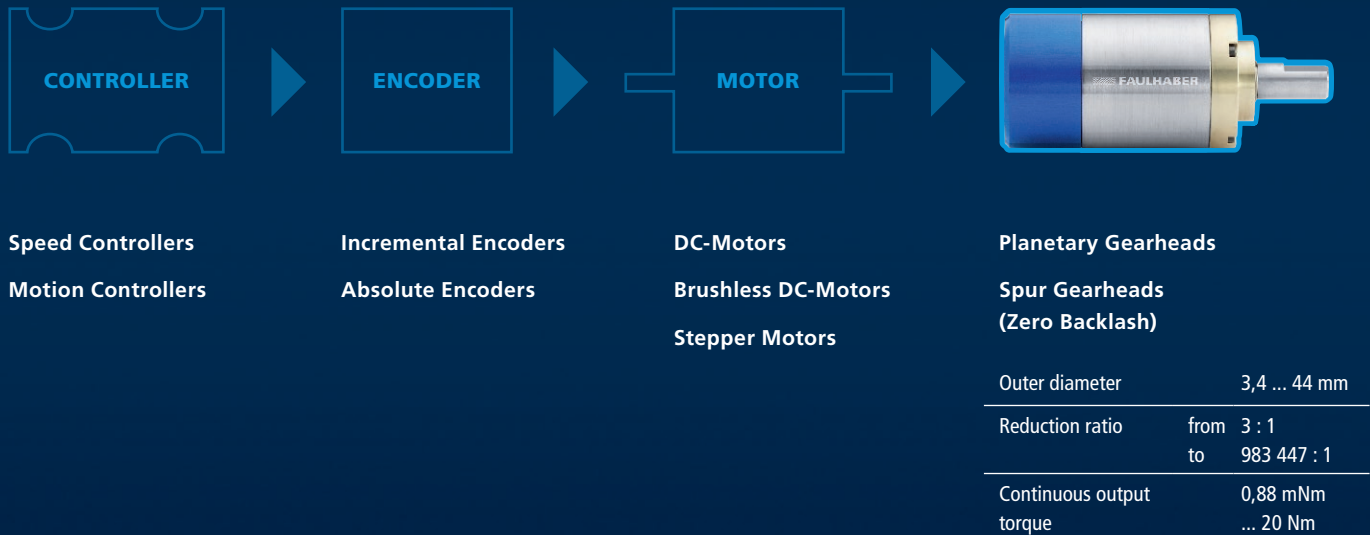



FAULHABER develops high performance modular gear-heads to complement each of its motor technologies.

From high torque planetary technology in a variety of materials, to zero backlash spur gears, FAULHABER has the right solution.

Features and benefits

Available in a wide variety of reduction ratios ·
Zero backlash versions are available · Available with a variety of shaft bearings including sintered, ceramic, and ball bearings

Linear Actuators

With gearhead or direct drive

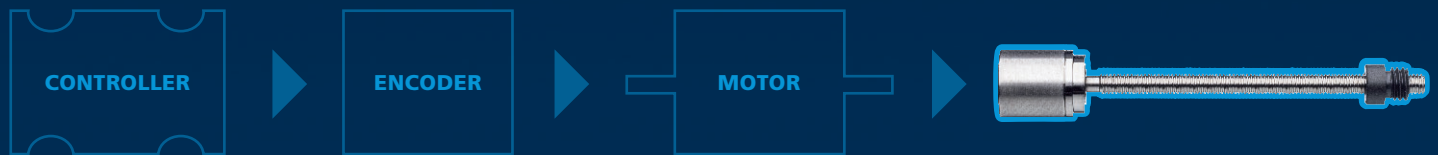

Motion Controllers

Incremental Encoders

Stepper Motors

Direct Drive Linear Actuators
Geared Linear Actuators

| | |
|-------------------------|----------------|
| Lead screw diameter | M1.2 ... M10 |
| Lead screw length | 7.5 ... 450 mm |
| Continuous axial force | 5 ... 1 920 N |
| Continuous output speed | Up to 120 mm/s |



Thanks to their high-precision mechanical design, FAULHABER linear actuators are ideally suited for positioning tasks requiring a high degree of accuracy.

Combinations with DC-Micromotors with high-resolution encoders, integrated Motion Controllers or Stepper Motors represent the optimum system solution for the most demanding applications in optical systems, automation, medical technology, etc.

Features and benefits

Long service life · High efficiency · Variable length · Customized versions with special lubrication for extended application areas · High positioning accuracy thanks to considerably reduced play

Encoders

Incremental Encoders and Absolute Encoders

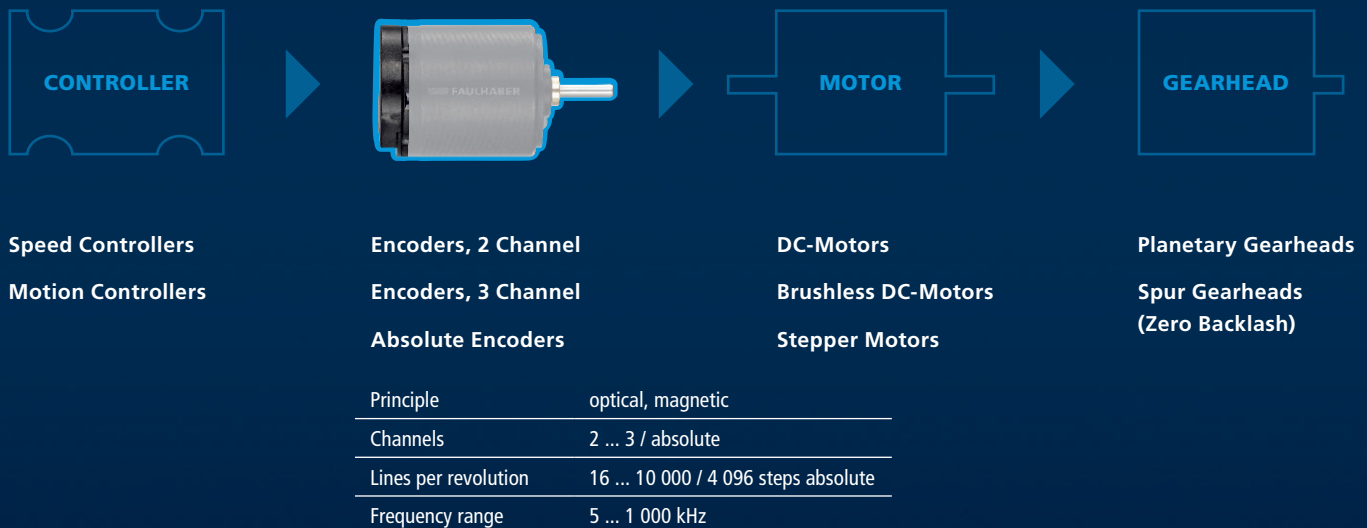



For higher positioning and speed control, FAULHABER provides a wide range of encoders to combine with the complete portfolio of FAULHABER DC, brushless, and stepper motors.

2 and 3 Channel incremental magnetic and optical encoders with standard quadrature resolution from 16 to up to 10 000 cpr or single turn absolute encoders with a resolution up to 4 096 steps are available.

Features and benefits

Extremely compact · High resolution of up to 40 000 steps per rotation (corresponds to a 0.009° angle resolution) · No pull-up resistors are necessary at the outputs because there are no open collector outputs · Symmetric switching edges, CMOS and TTL-compatible · Different resolutions, according to type, from 16 to 10 000 pulses, are available for standard delivery

Drive Electronics

Speed Controllers and Motion Controllers

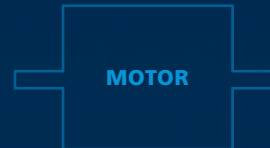
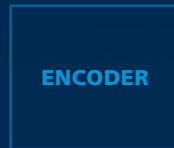

Speed Controllers

Motion Controllers

| | |
|---------------------------|-------------------------------------|
| Power supply | 4 ... 50 V |
| Continuous output current | up to 10 A |
| Interfaces | RS232 / USB / CANopen / EtherCAT |

Incremental Encoders

Absolute Encoders

DC-Motors

Brushless DC-Motors

Stepper Motors

Linear DC-Servomotors

Planetary Gearheads

Spur Gearheads (Zero Backlash)



A wide range of powerful, compact electronic components has been developed for FAULHABER drive systems.

FAULHABER Speed controllers are specifically designed to get the most out of FAULHABER DC and Brushless Motors.

FAULHABER Motion Controllers are highly dynamic, optimally tuned positioning controllers for use in combination with DC-micromotors as well as BL and LM DC-servomotors from FAULHABER's line of motors.

Features and benefits

Compact design · Precise and dynamic control · Flexible configuration for different motor types · Configuration via USB interface adapter · Easy to use Motion Manager software



FAULHABER WEBINARS – DRIVEN BY KNOWLEDGE

Our webinars offer you an opportunity to learn more about our products and solutions from anywhere. Our drive experts will be presenting interesting tools and application know-how as well as answer any questions you may have at the end of each session. Those who have missed the FAULHABER webinars can now access them online at any time in our webinar library.

Tools and support

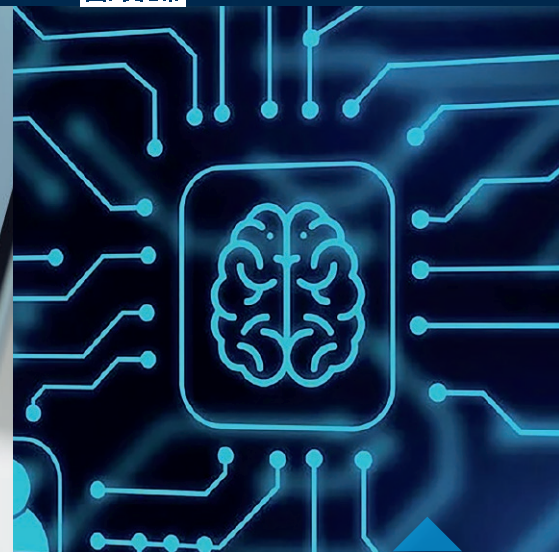

APPLICATION NOTES

These offer detailed information beyond the datasheet and are available for most of our motor series, for different types of our encoders and interfaces as well as for the Speed Controllers, Motion Controllers V2.5 and Motion Controllers V3.0.

WE CREATE MOTION

FAULHABER GROUP

Drive Systems

HEADQUARTERS

**DR. FRITZ FAULHABER
GMBH & CO. KG**
Germany

SUBSIDIARIES

FAULHABER Asia Pacific Pte Ltd
Singapore

FAULHABER Austria GmbH
Austria

FAULHABER Benelux B.V.
Netherlands

**FAULHABER Drive System
Technology (Taicang) Co., Ltd.**
China

FAULHABER France SAS
France

FAULHABER Italia S.r.l.
Italy

FAULHABER Malaysia Sdn Bhd
Malaysia

FAULHABER MICROMO LLC
USA

FAULHABER Motors Hungaria Kft.
Hungary

FAULHABER Motors Romania S.R.L.
Romania

FAULHABER Polska sp. z o.o.
Poland

FAULHABER SA
Switzerland

US



Micro Precision Systems

HEADQUARTERS

**MPS Micro Precision
Systems AG**
Switzerland

SUBSIDIARIES

MPS Décolletage SA
Switzerland

MPS Precimed SA
Switzerland

WE CREATE MOTION

FAULHABER worldwide

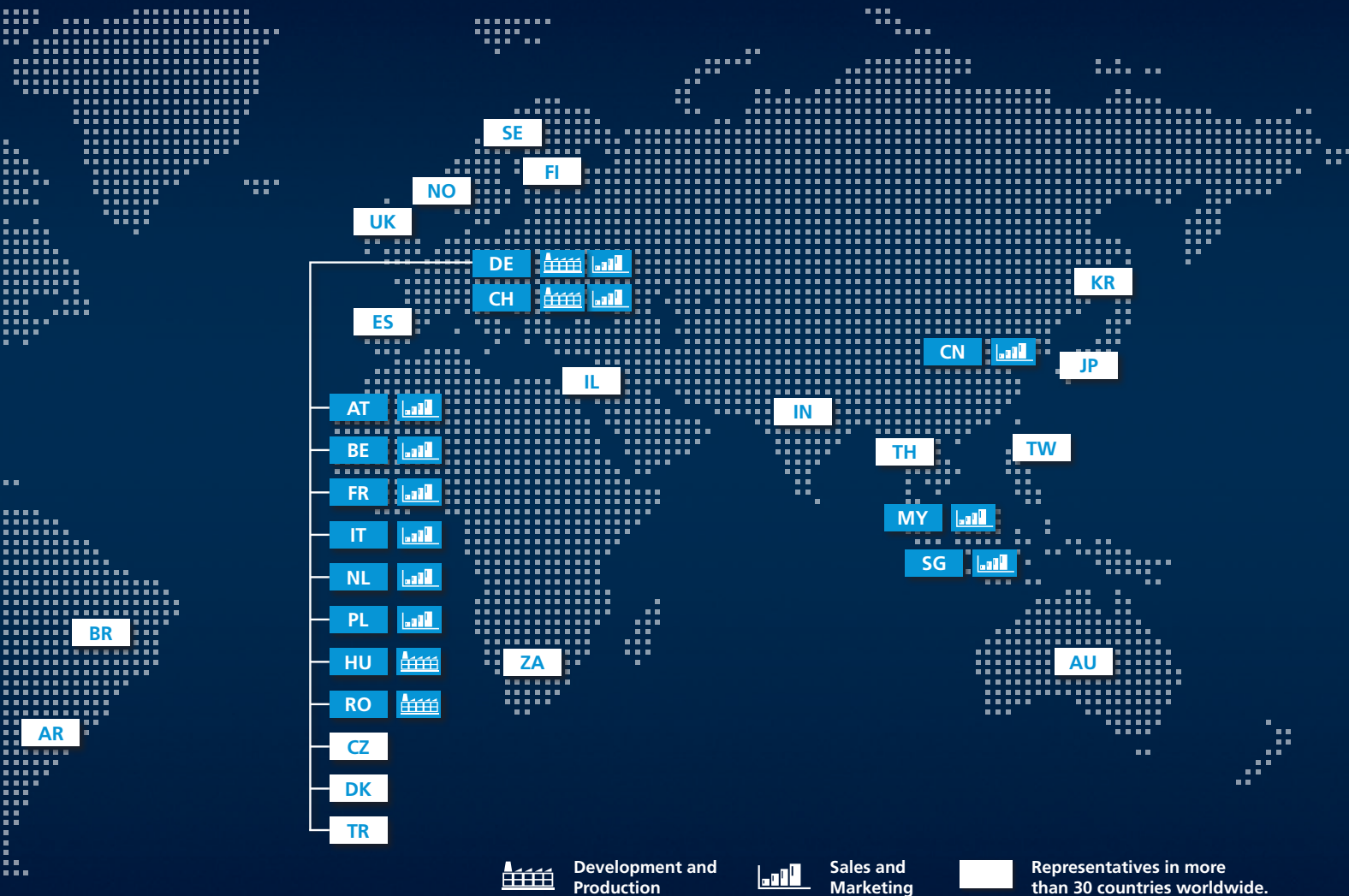

Development and Production



Sales and Marketing



Representatives in more than 30 countries worldwide.

More information



[faulhaber.com](https://www.faulhaber.com)



[faulhaber.com/facebook](https://www.faulhaber.com/facebook)



[faulhaber.com/youtube](https://www.faulhaber.com/youtube)



[faulhaber.com/linkedin](https://www.faulhaber.com/linkedin)



[faulhaber.com/instagram](https://www.faulhaber.com/instagram)

Your local contact



Ident-Nr. 000.9012.23